

3I380D

Intel Bay Trail-I E3815 (Single Core) /

Intel Bay Trail-D J1900 (Quad Core) CPU, On Board /

Socket DDR3L, 4 x Intel I211AT LAN / USB / VGA / HDMI

All-In-One

Intel Bay Trail-I E3815 1.46 GHz / Intel Bay Trail-D J1900 2.0GHz

VGA, HDMI, COM, PCIe mini card

Multi-LAN Board, SATA, USB

CAUTION

**RISK OF EXPLOSION IF BATTERY IS REPLACED
BY AN INCORRECT TYPE.**

**DISPOSE OF USED BATTERIES ACCORDING
TO THE INSTRUCTIONS**

Contents

3I380D	
Warning!.....	1
Hardware Notice Guide	2
CHAPTER 1 GENERAL INFORMATION	4
1-1 MAJOR FEATURE.....	5
1-2 SPECIFICATION	6
1-3 INSTALLING THE SO-DIMM (FOR 3I380D-D90)	7
1-3-1.1 REMOVING THE SO-DIMM (FOR 3I380D-D90)	9
1-4 DIRECTIONS FOR INSTALLING THE MINI CARD	10
1-5 PACKING LIST (FOR 3I380D-D90)	11
1-5-1 PACKING LIST (FOR 3I380D-I12)	12
CHAPTER 2 HARDWARE INSTALLATION	13
2-1 UNPACKING PRECAUTION	13
2-2 UNPACKING CHECKUP	14
2-3 DIMENSION (3I380D)	15
2-4 LAYOUT (3I380D)	16
2-5 DIAGRAM (3I380D-D90)	17
2-5-1 BOTTOM SIDE DIAGRAM (3I380D-D90)	18
2-5-2 DIAGRAM (3I380D-I12)	19
2-5-3 BOTTOM SIDE DIAGRAM (3I380D-I12)	20
2-6 INSTALL MEMORY	21
2-7 LIST OF JUMPERS	22
2-8 JUMPER SETTING DESCRIPTION	22
2-9 CMOS DATA CLEAR	23
2-10 JSC2: COM2 RS422/RS485 SELECT (OPTION)	24
CHAPTER 3 CONNECTION	25
3-1 LIST OF CONNECTORS.....	25
3-2 DC POWER INPUT	26
3-3 BATTERY INPUT	27
3-4 DC POWER OUTPUT	27
3-5 FRONT PANEL & FAN	28
3-6 DISPLAY INTERFACE	29
3-7 AUDIO INTERFACE (OPTION)	30
3-8 I/O INTERFACE	30
3-9 DIGITAL INPUT / OUTPUT (OPTION)	32
3-10 I ² C Bus Interface	33
3-11 PS2 KB/MS (OPTION)	33
3-12 LAN INTERFACE	33
3-13 USB INTERFACE	34

3-14 SATA INTERFACE	36
3-15 MICROSD CARD INTERFACE (SOCKET PUSH-PUSH) (OPTION)	36
3-16 MODULE SOCKET	37
3-17 SIM SOCKET	38
3-18 SODIMM SOCKET (OPTION)	38
3-19 CONNECTOR WAFER OF COMPATIBLE BRAND AND PART NUMBER LIST	39
CHAPTER 4 INTRODUCTION OF BIOS	40
4-1 ENTER SETUP	40
4-2 BIOS MENU SCREEN & FUNCTION KEYS	41
4-3 GENERAL HELP	42
4-4 MENU BARS	42
4-5 MAIN	43
4-6 ADVANCED	44
4-6-1 BOOT CONFIGURATION	45
4-6-2 PCI EXPRESS CONFIGURATION	46
4-6-2-1 PCI EXPRESS ROOT PORT 1/2/3/4	47
4-6-2-2 PCIE PORT 1/2/3/4 SPEED	48
4-6-2-3 PCIE PORT 1/2/3/4 OPTION ROM	49
4-6-3 USB CONFIGURATION	50
4-6-4 VIDEO CONFIGURATION	51
4-6-5 THERMAL CONFIGURATION	53
4-6-6 SATA CONFIGURATION	54
4-6-7 CONSOLE REDIRECTION	55
4-6-8 ACPI TABLE / FETURES CONTROL	56
4-7 SECURITY	57
4-8 POWER	58
4-9 BOOT	59
4-9-1 LEGACY	60
4-10 EXIT	62
4-11 DEVICE MANAGER	63
4-11-1 SIO FINTEK8180U	64
CHAPTER 5 DRIVER INSTALLATION	66
5-1 INF INSTALL INTEL BAYTRAIL CHIPSET DRIVER (EXAMPLE FOR WIN8 64BIT)	68
5-2 VGA INSTALL INTEL BAYTRAIL VGA DRIVER (EXAMPLE FOR WIN8 64BIT)	70
5-3 SERIAL IO INSTALL DRIVER BAYTRAIL SERIAL IO DRIVER (FOR WINDOWS 7 ONLY)	72
5-4 XHCI INSTALL INTEL USB 3.0 XHCI DRIVER (FOR WINDOWS 7 ONLY)	74
5-5 HD AUDIO INSTALL HIGH DEFINITION AUDIO DRIVER (EXAMPLE FOR WIN 64BIT)	76
5-6 MBI INSTALL INTEL MBI DRIVER (FOR WIN 8/8.1 ONLY)	77
5-7 TXE LNSTALL INTEL TXE DRIVER	79
5-7-1 TXE INSTALL FOR WIN8/WIN8.1	79
5-7-2 TXE INSTALL FOR WIN7	81

5-8 HOW TO UPDATE AMI BIOS	83
APPENDIX A:POWER CONSUMPTION TEST	84
APPENDIX B:RESOLUTION LIST	86
APPENDIX C: F75111N I ² C DIO DECICE	87
1-1 IO DEVICE : F75111 UNDER WINDOWS	87
1-2 IO DEVICE : F75111 VB6 UNDER WINDOWS	90
1-3 IO DEVICE : F75111 UNDER LINUX	92

Copyright

This manual is copyrighted and all rights are reserved. It does not allow any non authorization in copied, photocopied, translated or reproduced to any electronic or machine readable form in whole or in part without prior written consent from the manufacturer.

In general, the manufacturer will not be liable for any direct, indirect, special, incidental or consequential damages arising from the use of inability to use the product or documentation, even if advised of the possibility of such damages.

The manufacturer keeps the rights in the subject to change the contents of this manual without prior notices in order to improve the function design, performance, quality, and reliability. The author assumes no responsibility for any errors or omissions, which may appear in this manual, nor does it make a commitment to update the information contained herein.

Trademarks

Intel is a registered trademark of Intel Corporation.

Award is a registered trademark of Award Software, Inc.

All other trademarks, products and or product's name mentioned here are for identification purposes only, and may be trademarks and/or registered trademarks of their respective companies or owners.

© Copyright 2014

All Rights Reserved.

User Manual edition 0.1, Apr. 22. 2014

Warning !

1. Battery
Batteries on board are consumables.
The life time of them are not guaranteed.
2. Fanless solution with HDD
The specification & limitation of HDD should be considered carefully when the fanless solution is implemented.
3. We will not give further notification in case of changes of product information and manual.
4. SATA interface does not support Hot SWAP function.
5. There might be a 20% inaccuracy of WDT at room temperature.
6. Please make sure the voltage specification meets the requirement of equipment before plugging in.
7. There are two types of SSD, commercial grade and industrial grade, which provide different read / write speed performance, operation temperature and life cycle. Please contact sales for further information before making orders.
8. Caution! Please notice that the heat dissipation problem could cause the MB system unstable. Please deal with heat dissipation properly when buying single MB set.
9. Please avoid approaching the heat sink area to prevent users from being scalded with fanless products.
10. If users repair, modify or destroy any component of product unauthorizedly, We will not take responsibility or provide warranty anymore.
11. DO NOT apply any other material which may reduce cooling performance onto the thermal pad.
12. It is important to install a system fan toward the CPU to decrease the possibility of overheating / system hanging up issues, or customer is suggested to have a fine cooling system to dissipate heat from CPU.

* Hardware Notice Guide

1. Before linking power supply with the motherboard, please attach DC-in adapter to the motherboard first. Then plug the adapter power to AC outlet.
Always shut down the computer normally before you move the system unit or remove the power supply from the motherboard. Please unplug the DC-in adapter first and then unplug the adapter from the AC outlet.
Please refer photo 1 as standard procedures.
2. In case of using DIRECT DC-in (without adapter), please check the allowed range for voltage & current of cables. And make sure you have the safety protection for outer issues such as short/broken circuit, overvoltage, surge, lightning strike.
3. In case of using DC-out to an external device, please make sure its voltage and current comply with the motherboard specification.
4. The total power consumption is determined by various conditions (CPU / motherboard type, device, application, etc.). Be cautious to the power cable you use for the system, one with UL standard will be highly recommended.
5. It's highly possible to burn out the CPU if you change / modify any parts of the CPU cooler.
6. Please wear wrist strap and attach it to a metal part of the system unit before handling a component. You can also touch an object which is ground connected or attached with metal surface if you don't have wrist strap.
7. Please be careful to handle & don't touch the sharp-pointed components on the bottom of PCBA.
8. Remove or change any components from the motherboard will VOID the warranty of the motherboard.
9. Before you install / remove any components or even make any jumper setting on the motherboard, please make sure to disconnect the power supply first.
(follow the aforementioned instruction guide)
10. "POWERON after PWR-Fail" function must be used carefully as below:
When the DC power adaptor runs out of power, unplug it from the DC current;
Once power returns, plug it back after 5 seconds.
If there is a power outage, unplug it from the AC current, once power returns, plug it back after 30 seconds. Otherwise it will cause system locked or made a severe damage.

Remark 1:

Always insert / unplug the DC-in horizontally & directly to / from the motherboard. DO NOT twist, it is designed to fit snugly. Moreover, erratic pull / push action might cause an unpredictable damage to the component & system unit.

Photo 1

Insert

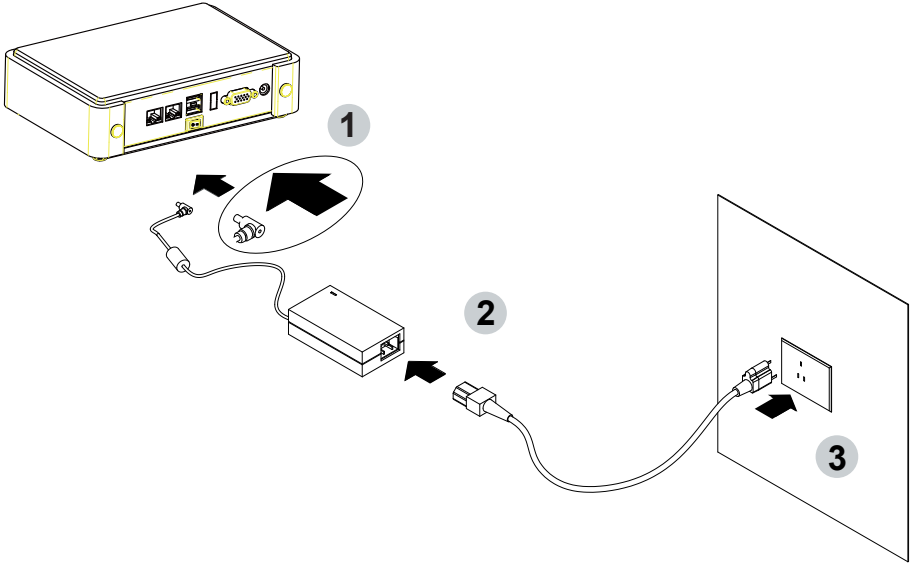

Unplug

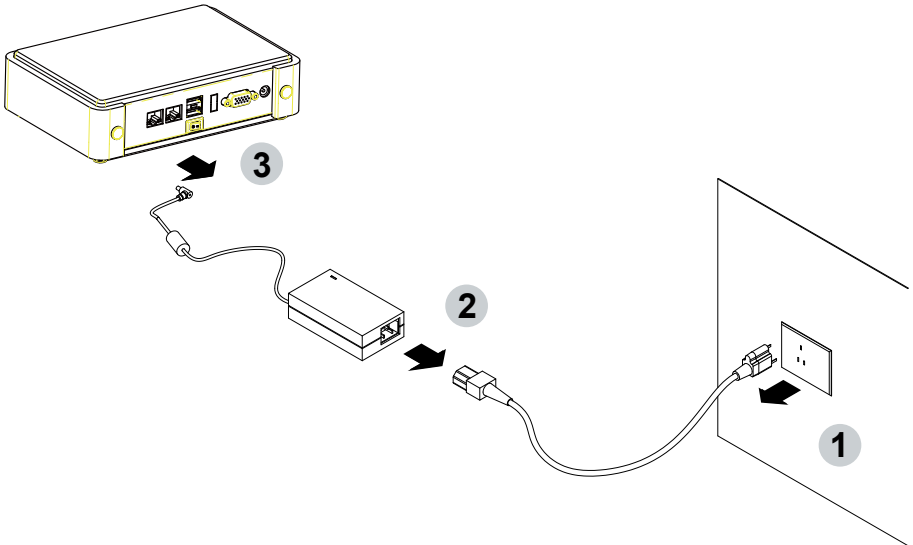

Chapter-1

General Information

The 3I380D is built to be an all-in-one networking control board. It's designed to combine all necessary input and output interfaces, which make them to be ideal control board for thin client, firewall or server applications. 3I380D is the perfect platform for whole range of small form factor, low-power devices.

High-performance and power-efficient networking platform, the embedded motherboard 3I380D is specially designed for advanced embedded VPN or firewall applications where the economical use of power is in high demand. With the sizable memory bandwidth of on board 2GB DDR3L or DDR3L SODIMM socket or the flexibility of expanding the memory to 4GB DDR3L SODIMM socket, 3I380D ensures the high performance level required of today's most popular firewall applications. 3I380D supports with four 10/100/1000 Mbps Ethernet for seamless broadband connectivity. With Wake-On LAN function and the PXE function in BIOS, these are perfect control board for networking devices. The built-in LAN option includes four Intel I211AT LAN chipset for PCIe x 1 V2.1 interface with RJ45 for 10/100/1000 Mbps Ethernet. 3I380D also offers two COM ports (by wafer connection) to meet the needs of COM port connectivity.

3I380D integrates PCIe mini card for mSATA & USB & SIM card interfaces. In addition, with EHCI high-speed host controller interface; it ensures the high performance level and also the powerful and flexible expansion. Moreover, a single flash chip holds the system BIOS, and you can change the flash BIOS by the Utility Update.

The 3I380D all-in-one motherboard is fully compatible with industrial standards, plus technical enhancements and thousands of software applications developed for IBM PC/AT compatible computers. The control logic provides high-speed performance for the most advanced multi user and multitasking applications available today.

1-1 Major Feature

1. Intel Bay Trail-I E3815 1.46GHz / Intel Bay Trail-D J1900 2.0/2.42(Burst)GHz SOC
2. Intel Bay Trail-I Integrated Graphics chipset:
Bay Trail-I E3815 Graphics speed: 400MHz
Bay Trail-D J1900 Graphics speed: 688MHz/854MHz(Turbo)
3. 1 x DDR3L SO-DIMM socket or On board DDR3L SDRAM (max. 4GB)
4. On board SSD 4/8/16/32 GB (option)
5. Support 4 x 10/100/1000 Mbps LAN on Board
(Intel I211AT LAN chipset for PCIe x 1 V2.1 interface)
6. Support 1 pair LAN Bypass function when DC Power off (option)
7. Support 1 x SATA, 7 x USB
8. Support PCIe mini cards including one for USB & SIM card interfaces,
another one for USB & mSATA interface
9. On board DC +12V Power Supply (Note: -5V, -12V no support)
10. Compact PCB Dimension: 145 x 102 mm (3.5 inch)
11. One 3G SIM card reader (for 3G mini card use)

1-2 Specification

1. **SOC** : Intel Bay Trail-I E3815 1.46GHz (Single core) /
Intel Bay Trail-D J1900 2.0/2.42(Burst)GHz (Quad core)
2. **Memory** : 1 x DDR3L SO-DIMM socket or On board DDR3L SDRAM (max. 4GB)
3. **VGA** : Intel Bay Trail-I Integrated Graphics chipset:
Bay Trail-I E3815 Graphics speed: 400MHz
Bay Trail-D J1900 Graphics speed: 688MHz/854MHz(Turbo)
4. **I/O Chip** : F81801U I/O chipset
5. **SATA** : One SATA port with independent DMA operation supported
6. **NAND flash memory**: On board SSD 4/8/16/32 GB (option)
7. **LAN** : 4 x Intel I211AT LAN chipset or Intel I210AT LAN chipset (option)
with 10/100/1000 Mbps for PCIe x 1 V2.1 interface
8. **Serial Port** : 2 x COM
9. **USB** : 6 x USB 2.0 (3 external + 3 internal) & 1 x USB 2.0/3.0 (internal)
10. **Sound (option)** : ALC886 HD Audio Specification 1.0 Two channel sound
11. **LAN Bypass (option)** : support 100Mb LAN Bypass function when DC Power off
12. **DIO (option)** : Fintek F75111N chipset for 4DI/4DO
13. **WDT (option)**: F81801U IO chipset for hardware watch dog timer support,
0~255 sec programmable
14. **Expansion interface** : 2 x PCIe mini card including one PCIe Mini card for
USB & SIM card interfaces, one PCIe Mini card for USB & mSATA interface
15. **BIOS** : Insyde UEFI BIOS
16. **Dimension** : 145 x 102 mm (3.5 inch)
17. **Power** : On board DC +12V (Note: -5V, -12V no support)
18. **3G Wireless** : one 3G SIM card reader (for 3G mini card use)

1-3 Installing the SO-DIMM (for 3I380D-D90)

1. Align the SO-DIMM with the connector at a 45 degree angle.



2. Press the SO-DIMM into the connector until you hear a click.



Notices:

1. The connectors are designed to ensure the correct insertion. If you feel resistance, check the connectors & golden finger direction, and realign the card.

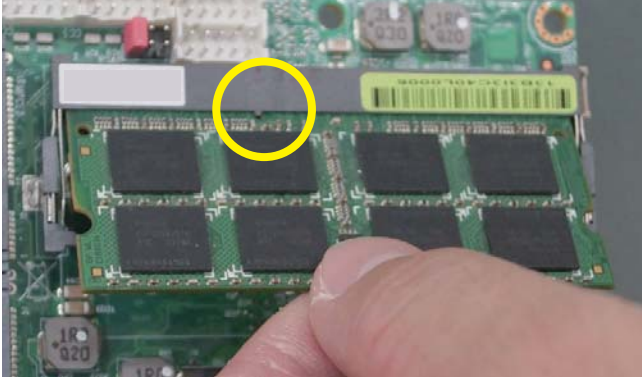

2. Make sure the retaining clips (on two sides of the slot) lock onto the notches of the card firmly.

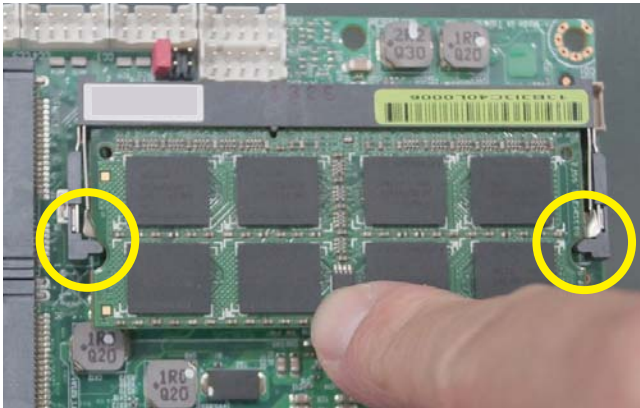

1-3-1.1 Removing the SO-DIMM (for 3I380D-D90)

1. Release the SO-DIMM by pulling outward the two retaining clips and the SO-DIMM pops up slightly.



2. Lift the SO-DIMM out of its connector carefully.

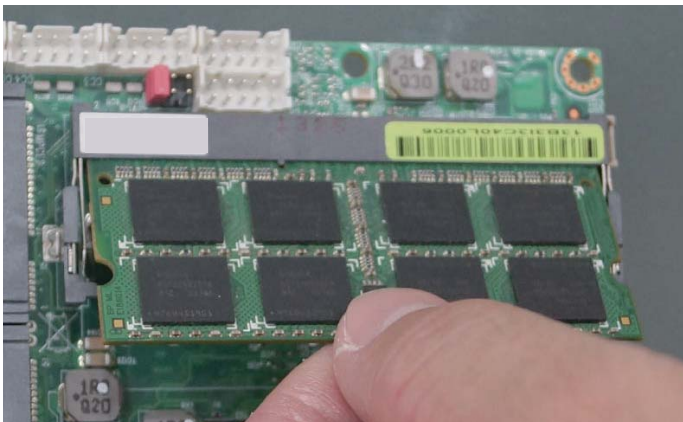

1-4 Directions for installing the Mini Card

1. Unscrew the screw on the board

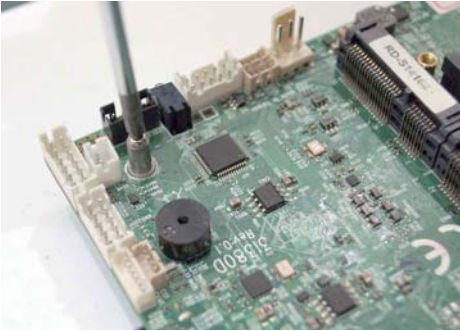

2. Plug in the Mini Card in a 45 angle

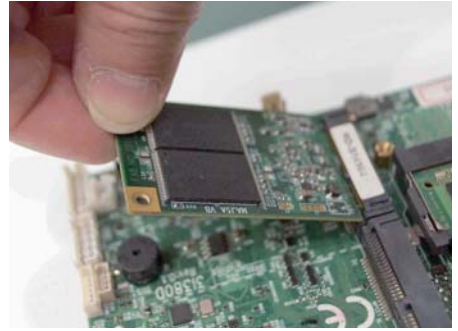

3. Gently push down the Mini Card and screw the screw back.



1-5 Packing List (For 3I380D-D90)

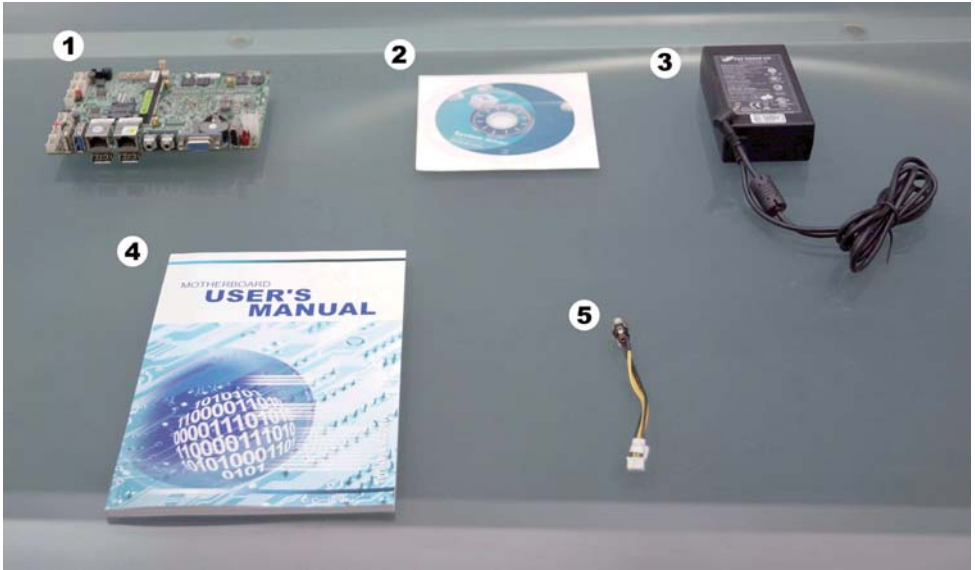

	Material Code	Description	Detail Specification	Quantit
1	7G1901-1481001-0	MB-3I380D-D90-00-001	LF,3I380D-D90-00,Rev.:001	1
2	6G8006-2347-0100	LEX Product Driver DVD	LF, Intel Baytrail Driver	1
3	6G5212-0601-0200	60W Power Adapter,12V/5A,2.5	LF,L Type,FSP060-DBAE1,FSP	1
4	6G8001-2191-0400	Manual	LF,M/B,3I380D	1
5	6G6003-7330-0100	Power Cable	LF,L=9cm,2.0 1*4/DC JK	1

**Optional accessories (items in addition to motherboard)
are not included in the standard packing.
Please contact your dealer to purchase the optional accessories.**

1-5-1 Packing List (For 3I380D-I12)

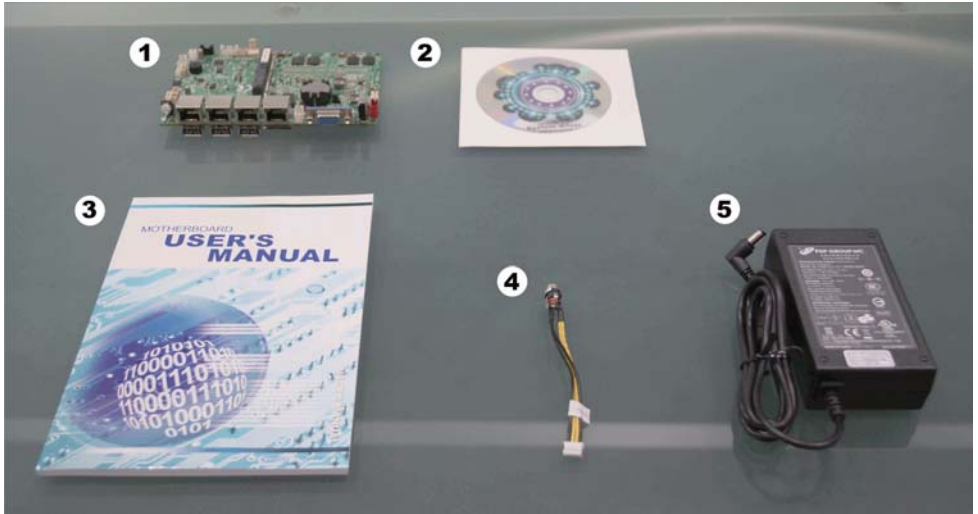

	Material Code	Description	Detail Specification	Quantit
1	7G1901-1480001-0	MB-3I380D-I12-00-001	LF,3I380D-I12-00,Rev.:001	1
2	6G8006-2347-0100	LEX Product Driver DVD	LF, Intel Baytrail Driver	1
3	6G5212-0601-0200	60W Power Adapter,12V/5A,2.5	LF,L Type,FSP060-DBAE1,FSP	1
4	6G8001-2191-0400	Manual	LF,M/B,3I380D	1
5	6G6003-7330-0100	Power Cable	LF,L=9cm,2.0 1*4/DC JK	1

**Optional accessories (items in addition to motherboard)
are not included in the standard packing.
Please contact your dealer to purchase the optional accessories.**

Chapter-2

Hardware Installation

2-1 Unpacking Precaution

This chapter provides the information how to install the hardware of 3I380D
Please follow section 1-5, 1-5-1, 2-1 and 2-2 to check the delivery package and unpack carefully. Please follow the jumper setting procedure.

NOTE!

1. Do not touch the board or any other sensitive components without all necessary anti-static protection.
2. Please pay attention to the voltage limitation of DC-IN 12V 5%.
Overuse of DC-IN voltage limitation or change to another power adapter (not provided with this system) will VOID warranty.

You should follow these
steps to protect the board from the static electric
discharge whenever you handle the board:

1. Ground yourself by a grounded wrist strap at all times when you handle the 3I380D.
Well secure the ALLIGATOR clip of the strap to the end of the shielded wire lead from a grounded object. Please put on and connect the strap before handling the 3I380D for harmlessly discharge any static electricity through the strap.
2. Please use anti-static pad to put any components, parts, or tools on the pad whenever you work on them outside the computer. You may also use the anti-static bag instead of the pad. Please ask your local supplier for necessary parts on anti-static requirement.
3. Do not plug any connector or set any jumper when the power is on.

2-2 Unpacking checkup

First of all, please follow all necessary steps of section 2-1 to protect 3I380D from electricity discharge. With reference to section 1-5,1-5-1 please check the delivery package again with following steps:

1. Unpack the 3I380D board and keep all packing material, manual and driver disc etc, do not dispose !
2. Is there any components lose or drops from the board?
DO NOT CONTINUE TO INSTALL THIS BOARD!
CONTACT THE DEALER YOU PURCHASED THIS BOARD FROM, IMMEDIATELY.
3. Is there any visible damage on the board?
DO NOT CONTINUE TO INSTALL THIS BOARD!CONTACT THE DEALER YOU PURCHASED THIS BOARD FROM, IMMEDIATELY.
4. Check your optional parts (i.e. DDR, CF etc.), all necessary jumpers setting to jumper pin-set, and CMOS setup correctly.
Please also refer to all information of jumper settings in this manual.
5. Check your external devices (i.e. Add-On-Card, Driver Type etc.) for complete add-in or connection and CMOS setup correctly.
Please also refer to all information of connector connection in this manual.
6. Please keep all necessary manual and driver disc in a good condition for future re-installation if you change your Operating System.

2-4 Layout-3I380D

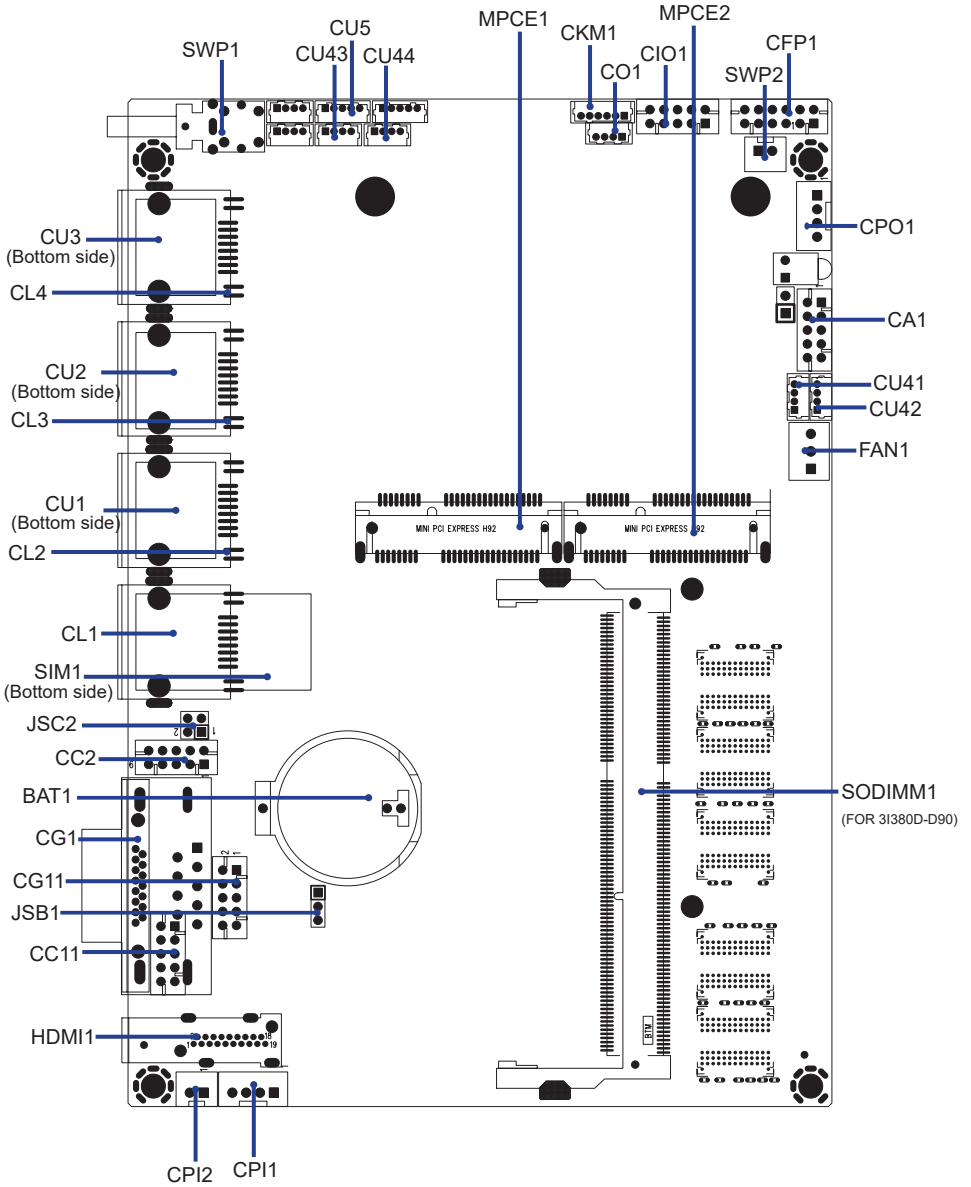

2-5 Diagram- 3I380D-D90

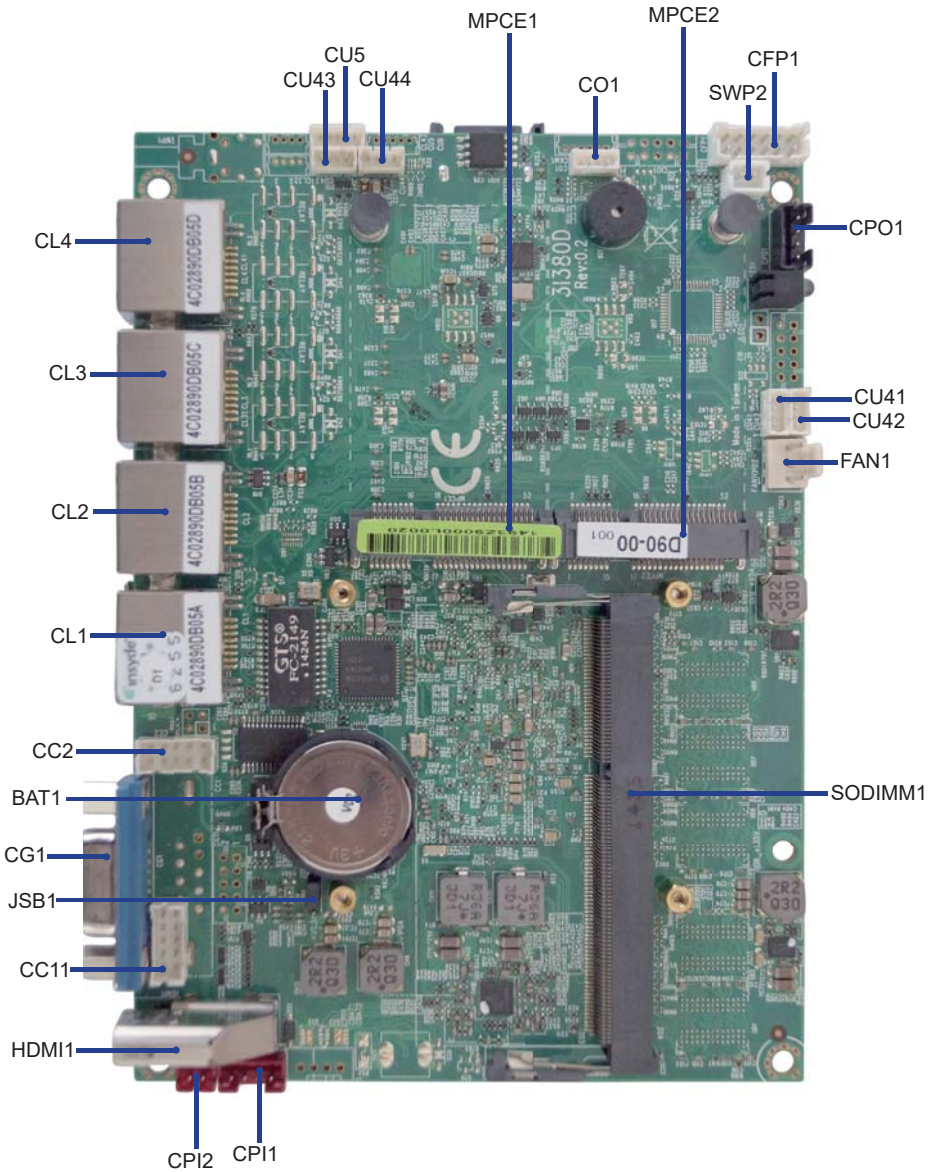

2-5-1 Bottom Side Diagram- 3I380D-D90

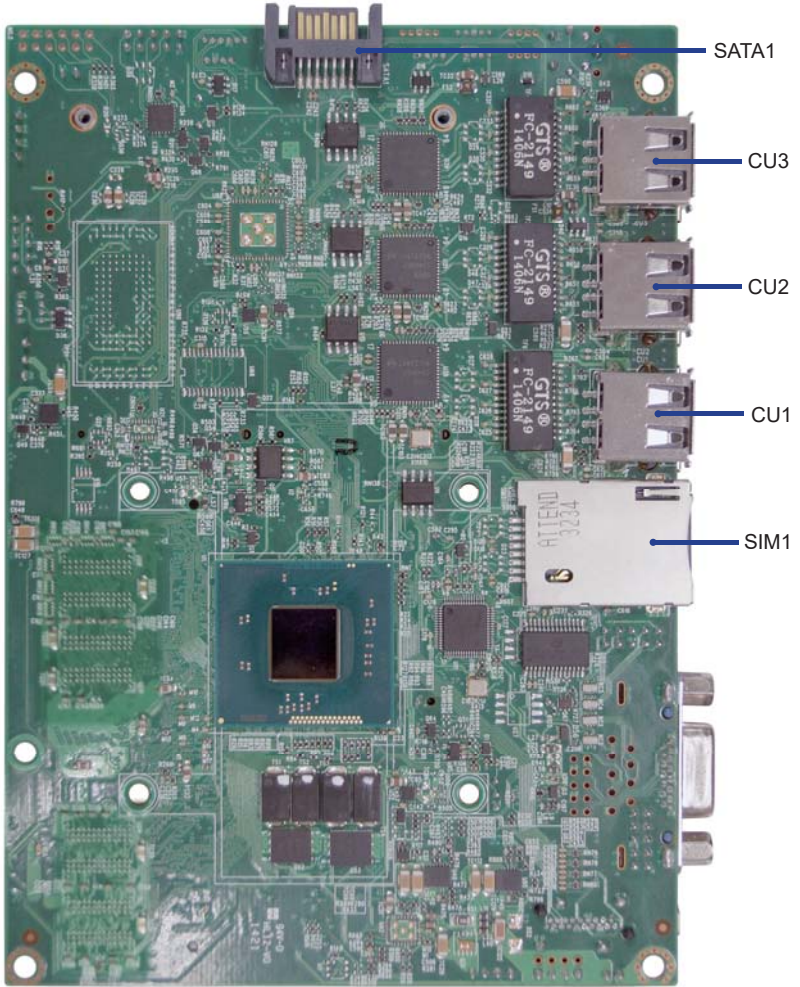

BACK Panel-3I380D-D90

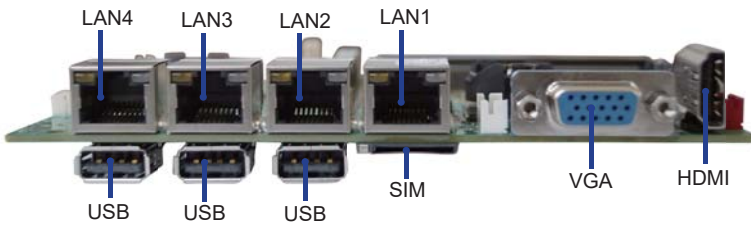

2-5-2 Diagram- 3I380D-I12

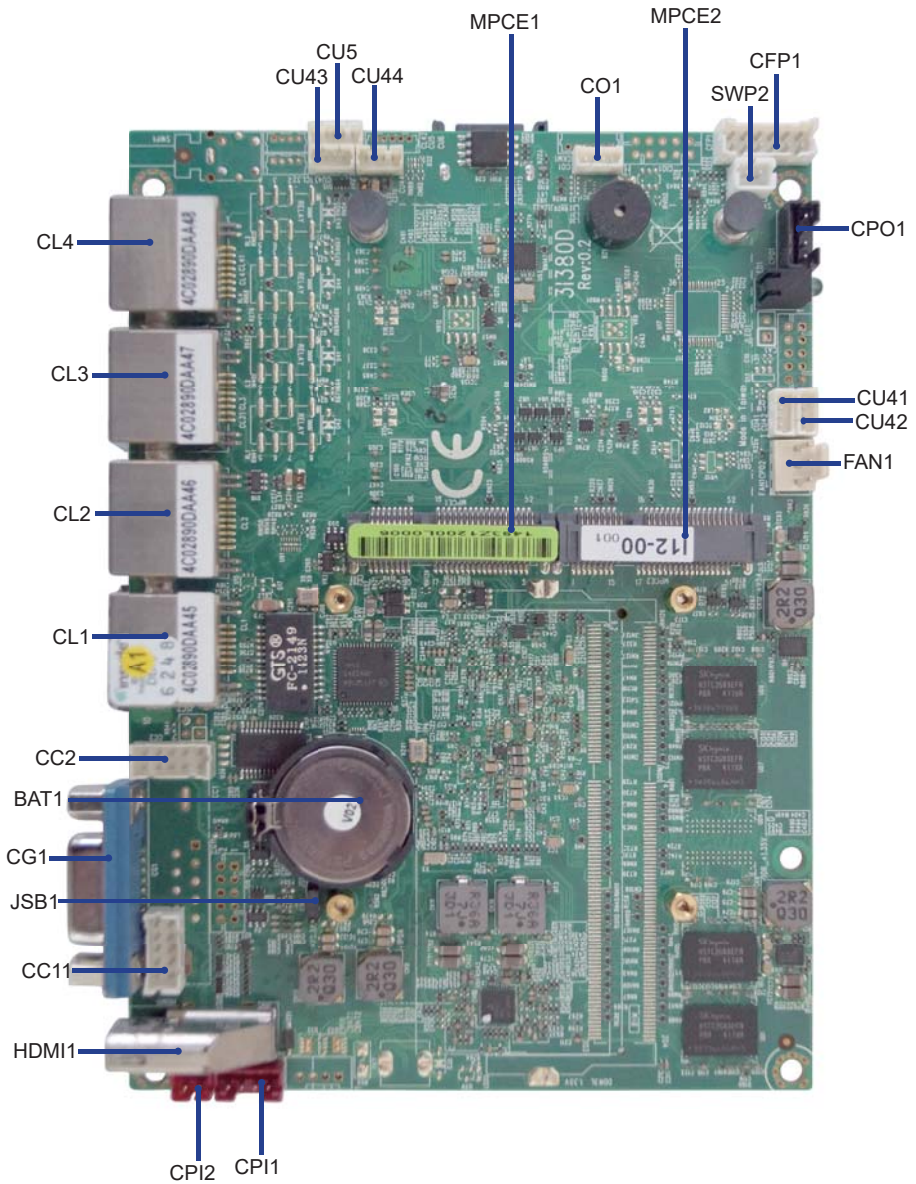

2-5-3 Bottom Side Diagram- 3I380D-I12

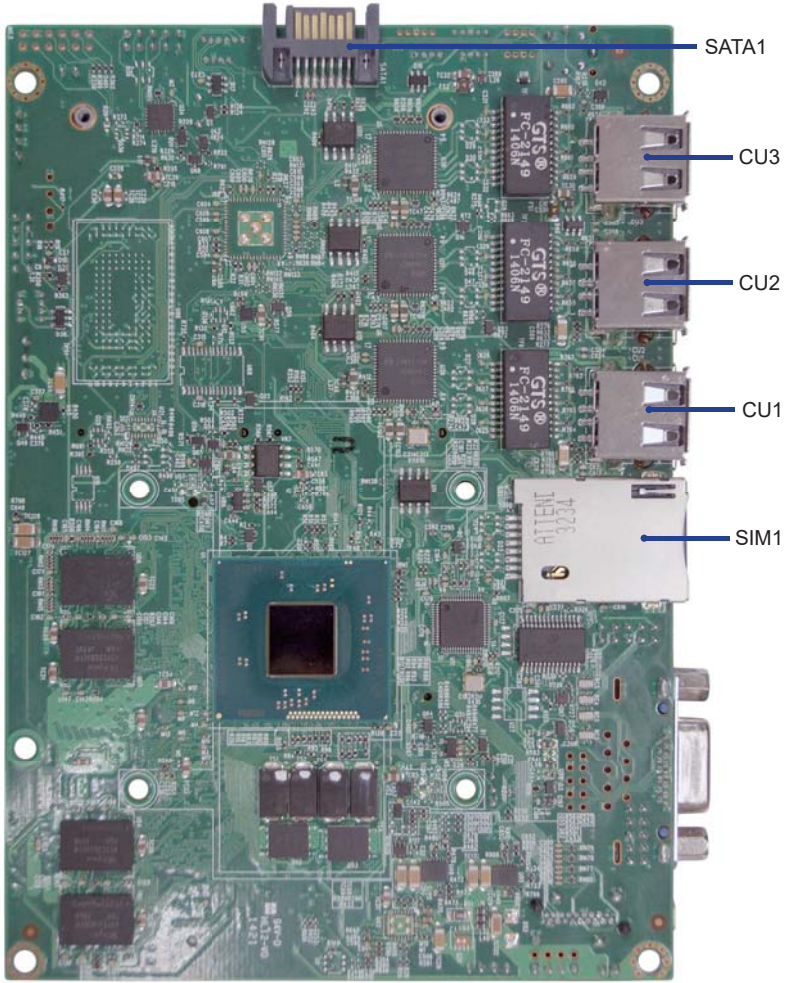

BACK Panel-3I380D-I12

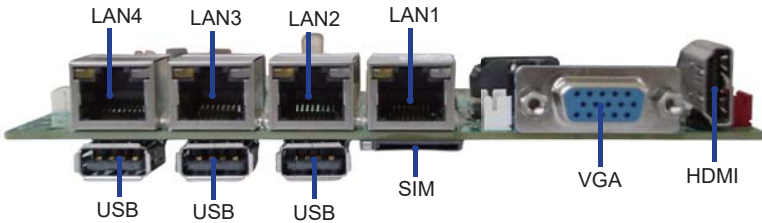

2-6 Install Memory

This motherboard provides one 204-pin Small Outline Dual In-line Memory Module (SODIMM) socket for memory expansion available maximum to of 2GB/4GB/8GB DDR3L SDRAM.
DDR3L clock supports: DDR3 1333/1066MT/S

Valid Memory Configurations

DIMM1	System Accept or Not	Total Memory
		Max.
DS/SS	Accept	8GB

DS: Double Sided DIMM

SS: Single Sided DIMM

NOTE!

The detected memory size is less than actual installed memory size since some memory has been allocated for system use.
That's how PC works with system memory.

Please refer to page 7 for installation of memory module.

2-7 List of Jumpers

JSB1: CMOS clear select

JSC2: COM2 RS422/RS485 select (Option)

2-8 Jumper Setting Description

A jumper is ON as a closed circuit with a plastic cap covering two pins. A jumper is OFF as an open circuit without the plastic cap. Some jumpers have three pins, labeled 1, 2, and 3. You could connect either pin 1 and 2 or 2 and 3. The below figure 2.2 shows the examples of different jumper settings in this manual.

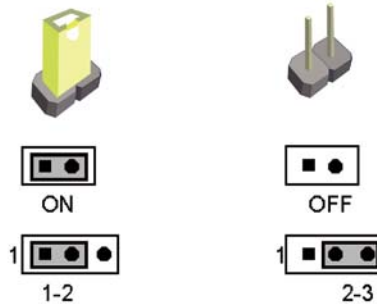

Figure 2.2

All jumpers already have its default setting with the plastic cap inserted as ON, or without the plastic cap as OFF. The default setting may be referred in this manual with a "*" symbol .

2-9 CMOS Data Clear

A battery must be used to retain the motherboard configuration in CMOS RAM. Close Pin1 and pin 2 of JSB1 to store the CMOS data.

To clear the CMOS, follow the procedures below:

1. Turn off the system and unplug the AC power
2. Remove DC 12V power cable from DC 12V power connector
3. Locate JSB1 and close pin 1-2 for few seconds
4. Return to default setting by close pin 1-2
5. Connect DC 12V power cable back to DC 12V Power connector

JSB1: CMOS Data Clear

JSB1	Description
1-2	Normal set
2-3	CMOS data clear

Note: Normal work is open jumper

Note: Do not clear CMOS unless

1. **Troubleshooting**
2. **Forget password**
3. **You fail over-clocking system**

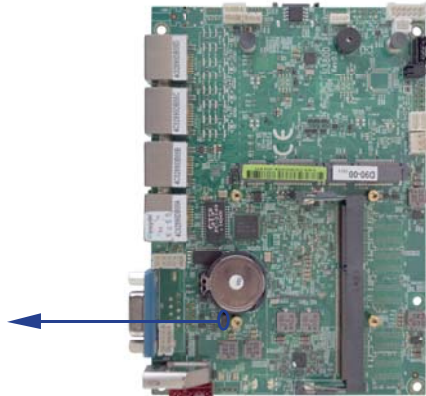
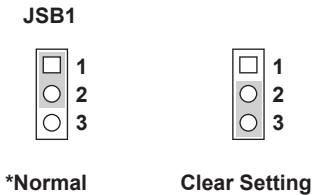

2-10 JSC2:COM2 RS422/RS485 select (Option)

JSC2	Description
*1-2	RS422
3-4	RS485

Note: RS422/485 setting by both H/W jumper and BIOS CMOS setting

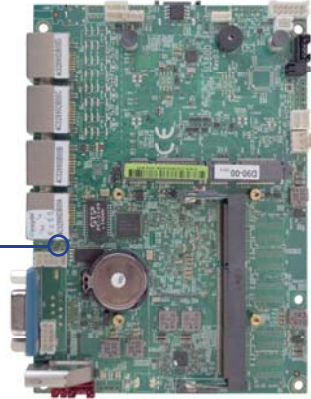
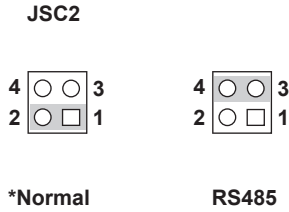

Chapter-3

Connection

This chapter provides all necessary information of the peripheral's connections, switches and indicators. Always power off the board before you install the peripherals.

3-1 List of Connectors

CPI1: DC-in 1x4pin(2.0mm) Red wafer connector
CPI2: DC-in 1x2 pin(2.0mm) Red wafer connector
CPI11: DC-in 2x4 pin(2.0mm) wafer connector (Option)
BAT1: Li 3V battery holder
CPO1: DC +5/+12V output 1x4 pin(2.0mm) Black wafer connector
CFP1: Front panel port 2x6 pin(2.00mm) wafer for LED
SWP1: Power Button /Power LED(Blue) (Option)
SWP2: Power Button 1x2 pin(2.0mm) wafer
FAN1: CPU fan 1x3 pin(2.54mm) wafer
CG1: DSUB VGA connector
CG11: DSUB VGA wafer connector (Option)
HDMI1: HDMI Type A 90° connector
CA1: Mic-in/Line out/Line in 2x5 pin(2.0mm) wafer connector (Option)
CC1: DB9 COM1 connector (Option)
CC11: COM1 2x5pin(2.0mm) wafer
CC2: COM2 2x5pin(2.0mm) wafer
CIO1: DI port 0 ~ 3, DO port 0 ~ 3 2x5 pin (2.0mm) wafer (Option)
CO1: I²C 4pin (1.25mm) wafer
CKM1: KB/MS port 1x6 pin (1.25mm) wafer connector (Option)
CL1/CL2/CL3/CL4: LAN RJ45 connector
CL11/CL21/CL31/CL41: LAN3/4 port 2x4 pin(2.0mm) wafer connector (Option)
CL32/CL42: LAN3/4 LED port 1x4 pin(1.25mm) wafer connector (Option)
CU1/CU2/CU3: USB port 1/2/3 Type A connector
CU41: USB2.0 port 4pin(1.25mm) wafer (share with MPCE1 USB signal)
CU42: USB2.0 port 4pin(1.25mm) wafer (share with MPCE2 USB signal)
CU5: USB3.0 port 5pin(1.25mm)wafer (For CU001 use)
CU43/CU44: USB2.0 port 4pin(1.25mm) wafer
SATA1: SATA port 0 (Gen III) connectors 7pin
MPCE1/MPCE2: Mini card port 1/2 sockets 52pin
SIM1: SIM port 1 card socket(push-push)
MSD1: MicroSD port socket(push-push) (Option)
SODIM1: SO-DIM DDR3L 1.35V DRAM Socket

3-2 DC power input

● CPI1: DC-IN Internal Connector (1x4pin 2.0mm Red wafer)

PIN NO.	Description	PIN NO.	Description
1	GND	2	+VAD_AC
3	+VAD_AC	4	GND

Note: 1. DC in from adapter plug in

● CPI2: DC-IN Internal Connector (1x2 pin 2.0mm Red Wafer)

PIN NO.	Description
1	+VAD_AC
2	GND

Note: DC in from adapter plug in

● CPI11: DC-IN Internal Connector (2x4 pin 2.0mm Wafer)(Option)

PIN NO.	Description	PIN NO.	Description
1	GND	2	GND
3	+VAD_AC	4	+VAD_AC
5	+VAD_AC	6	+VAD_AC
7	GND	8	GND

Note: 1. DC in from adapter plug in
2. Share with CPI1 Connector

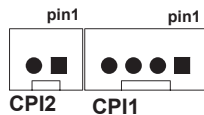

3-3 Battery Input

- **BAT1: 3V Battery hold 2pin**

BAT1: Battery use Li 3V / 220mAh (CR2032)

Note: 1. When board without Adaptor plug in, this board power RTC consumption about 2.7uA

2. If adaptor always plug in RTC power consumption about 0.1uA

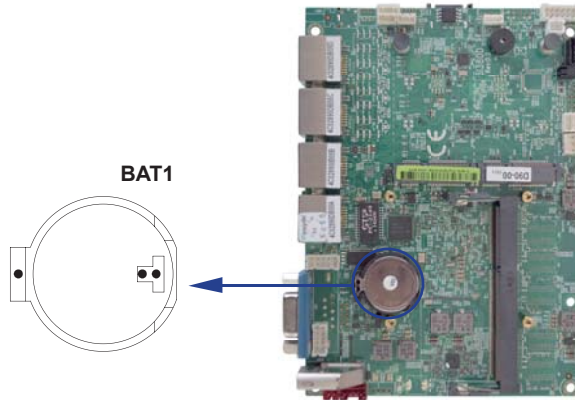

3-4 DC Power output

- **CPO1: +12V/+5V DC voltage output (1x4pin 2.00mm Black wafer)**

PIN NO.	Description
1	+5V
2	GND
3	GND
4	+12V*

Note: DC in +12V by switch to DC-out voltage +12V, so DC in need stable +12V input

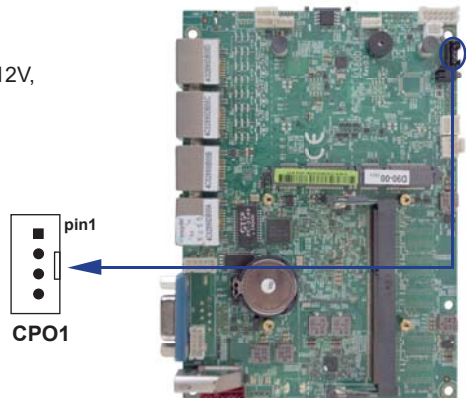

3-5 Front panel & FAN

• CFP1 Front panel LED connector (2x6pin 2.00mm wafer)

PIN NO.	Description	PIN NO.	Description
2	GND	1	Power LED+
4	GND	3	HDD LED+
6	LAN1 LED-	5	LAN1 LED+
8	LAN2 LED-	7	LAN2 LED+
10	LAN3 LED-	9	LAN3 LED+
12	LAN4 LED-	11	LAN4 LED+

Note: pin3 can OEM BOM set to reset pin

• SWP2 Power button connector (1x2pin 2.0mm wafer)

PIN NO.	Description
1	Power button pin
2	Power button GND

• FAN1: CPU FAN connector (1x3pin 2.54mm wafer)

PIN NO.	Description
1	GND
2	+12V
3	FAN speed detect

Note: DC in +12V by switch to FAN power +12V,
so DC in need stable +12V input

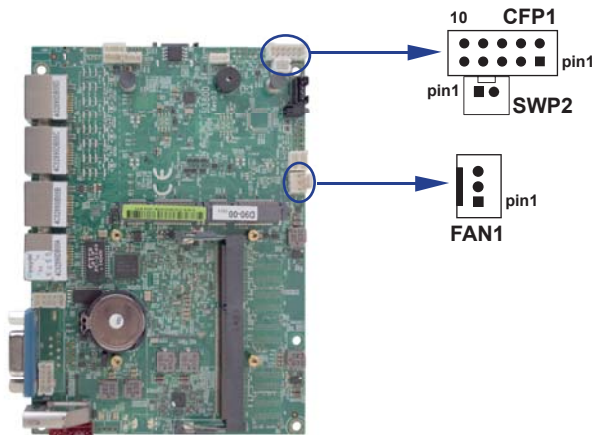

3-6 Display interface

● CG1: DSUB VGA connector (DB15 pin)

PIN NO.	Description	PIN NO.	Description	PIN NO.	Description
1	RED	6	GND	11	NC
2	GREEN	7	GND	12	DDC DATA
3	BLUE	8	GND	13	H-SYNC
4	NC	9	NC	14	V-SYNC
5	GND	10	GND	15	DDC CLOCK

● CG11: VGA wafer connector (2x5pin 2.0mm wafer) (Option)

PIN NO.	Description	PIN NO.	Description
1	BLUE	2	GND
3	GND	4	DDC CLOCK
5	GREEN	6	V-SYNC
7	GND	8	H-SYNC
9	RED	10	DDC DATA

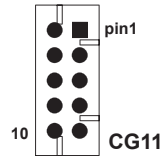

● HDMI1: HDMI Connector (Type A)

PIN NO.	Description	PIN NO.	Description
1	TMDS DATA2+	2	GND
3	TMDS DATA2-	4	TMDS DATA1+
5	GND	6	TMDS DATA1-
7	TMDS DATA0+	8	GND
9	TMDS DATA0-	10	TMDS CLK+
11	GND	12	TMDS CLK-
13	NC	14	NC
15	DDC CLK	16	DDC DATA
17	GND	18	+5V
19	H.P. Detect		

*Note: HDMI support 1.3a Spec



3-7 Audio interface (option)

- CA1: Mic in/Line in/Line out wafer connector (2x5pin 2.00mm wafer)

PIN NO.	Description	PIN NO.	Description
1	LINEOUT_R	2	MIC_IN
3	LINE_IN_R	4	GND
5	GND	6	SPDIF_O
7	LINE_IN_L	8	+5V
9	LINEOUT_L	10	MIC_IN

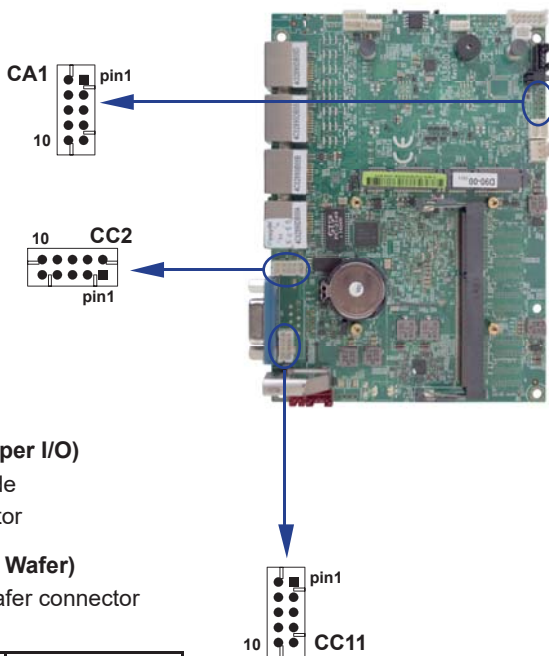

3-8 I/O Interface

- COM ports (COM1~COM6 from super I/O)

COM1/2 default support RS232 mode

CC1 share with CC11 wafer connector

- RS232 mode ports (2x5pin 2.0mm Wafer)

CC1: COM1 DB9 CC11: COM1 wafer connector

CC2: COM2 wafer connector

PIN NO.	Description	PIN NO.	Description
1	DCD	2	RXD
3	TXD	4	DTR
5	GND	6	DSR
7	RTS	8	CTS
9	RI	10	+5V

Note: 1. CC1 & CC11 wafer connector RS232 function for OEM BOM request

● **RS485 mode ports (2x5pin 2.0mm wafer)**

CC1: COM1 DB9 CC11: COM1 wafer connector
CC2: COM2 wafer connector

PIN NO.	Description	PIN NO.	Description
1	RS485 TX-	2	RS485 TX+
3	NC	4	NC
5	GND	6	NC
7	NC	8	NC
9	NC	10	+5V

Note: 1. CC1 & CC11 wafer connector RS485 function for OEM BOM request
2. BIOS need setting to RS485 mode

● **RS422 mode ports (2x5pin 2.0mm wafer)**

CC1: COM1 DB9 CC11: COM1 wafer connector
CC2: COM2 wafer connector

PIN NO.	Description	PIN NO.	Description
1	RS422 TX-	2	RS422 TX+
3	RS422 RX+	4	RS422 RX
5	GND	6	NC
7	NC	8	NC
9	NC	10	+5V

Note: 1. CC1 & CC11 wafer connector RS422 function for OEM BOM request
2. BIOS need setting to RS422 mode

3-9 Digital Input / Output (option)

● CIO1 DIO 0 ~ 3 (2x5pin 2.0mm wafer)

PIN NO.	Description	PIN NO.	Description
1	DI-0	2	DO-3
3	DI-1	4	DO-2
5	DI-2	6	DO-1
7	DI-3	8	DO-0
9	GND	10	+5V

- Note: 1. DI pin default pull up 10KΩ to +5V
 2. If use need isolate circuit to control external device
 3. F75111N-1 I²C bus address 0x9c



● For F75111N I²C DIO device:

DC spec:

Input low Voltage (VIL): +0.8 Max

Input High Voltage (VIH): +2V Min

Output low Current (IOL): 10mA (Min) VOL=0.4V

Output High Current (IOH): -10mA (Min) VOH=2.4V

Hardware watch Dog Timer support use F81801U

Watch Dog Time value 0~255sec

The system will be issued reset. When WDT is enable the hardware start down counter to zero.

The reset timer have 10~20% tolerance upon the Temperature.

Note: If want to SDK support. Please contact to sales window.

Please refer to page 87 for APPENDIX C: F75111N I²C DIO DECICE

3-10 I²C Bus Interface

- CO1: I²C (SM) bus connector (1x4pin 1.25mm wafer)

PIN NO.	1	2	3	4
Description	+3.3V	GND	SMB_CLK	SMB_DATA

3-11 PS2 KB/MS (option)

- CKM1: KB/MS port (1x6pin 1.25mm wafer)

PIN NO.	1	2	3	4	5	6
Description	+5V	KB/DAT	KB/CLK	GND	MS/DAT	MS/CLK

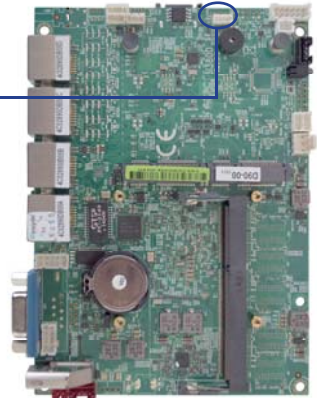
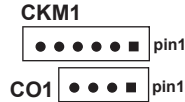

3-12 LAN Interface

- CL1 / CL2 / CL3 / CL4: LAN Giga/100Mb (RJ45 Jack)

PIN NO.	Description	PIN NO.	Description
1	TD0-/TX+	5	TD2-/NC
2	TD0+/TX-	6	TD2+/RX-
3	TD1-/RX+	7	TD3-/NC
4	TD1+/NC	8	TD3+/NC

- RJ45 LAN Connector--- LED define Giga/100MB Connector

SPEED		10 Mbps			100 Mbps			1000 Mbps		
Indicate	Side	Back		Front	Back		Front	Back		Front
	LED	Link	ACT	ACT	Link	ACT	ACT	Link	ACT	ACT
LAN Light			Orange	Orange	Green	Orange	Orange	Red	Orange	Orange

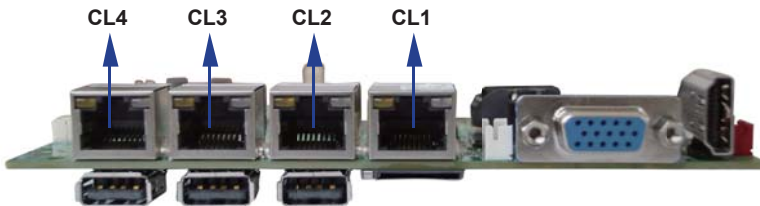

● **CL11/CL21/CL31/CL41: LAN port Giga /100Mb(2x4pin 2.0mm wafer) (Option)**

PIN NO.	Description	PIN NO.	Description
1	TD0-/TX+	2	TD2-/NC
3	TD0+/TX-	4	TD2+/RX-
5	TD1-/RX+	6	TD3-/NC
7	TD1+/NC	8	TD3+/NC

● **CL32/CL44 : LAN LED wafer (1x4pin 1.25mm wafer) (Option)**

PIN NO.	1	2	3	4
Description	+3.3V	Speed 10M	Speed 100M	Speed 1000M

3-13 USB Interface

● **CU1 / CU2 / CU3: USB1/2/3 ports (USB Type A connector)**

PIN NO.	Description
1	+5V
2	USB DATA -
3	USB DATA +
4	GND

Note: 1. Attention ! Check Device Power in spec

● **CU41 / CU42: Internal USB ports (1x4pin 1.25mm wafer)**

PIN NO.	Description
1	+5V
2	USB DATA -
3	USB DATA +
4	GND

Note: 1. Attention ! Check Device Power in spec

- CU41 share Mini card1 USB signal.
- CU42 share Mini card2 USB signal.

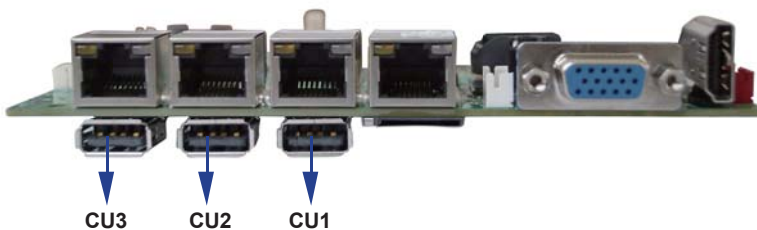
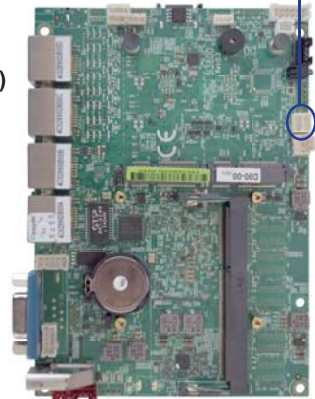
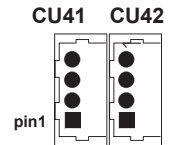

● **CU5: USB3.0 only port (1x5pin 1.25mm wafer) (For CU001 use)**

PIN NO.	Description
1	USB3_TX+
2	USB3_TX-
3	GND
4	USB3_RX+
5	USB3_RX-

Note: 1. If use CU5 must to use CU43 (4pin 1.25mm Wafer)

● **CU43 / CU44: Internal USB ports (1x4pin 1.25mm wafer)**

PIN NO.	Description
1	+5V
2	USB DATA -
3	USB DATA +
4	GND

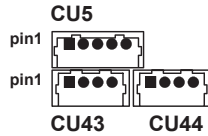

3-14 SATA interface

• SATA1: SATA1 connector

PIN NO.	Description
1	GND
2	DATA TX+
3	DATA TX-
4	GND
5	DATA RX-
6	DATA RX+
7	GND

Note: 1. SATA1 support SATA 2.0 spec update 3Gb/sec.
 2. CPO1 provide SATA HDD power +12V, GND, +5V

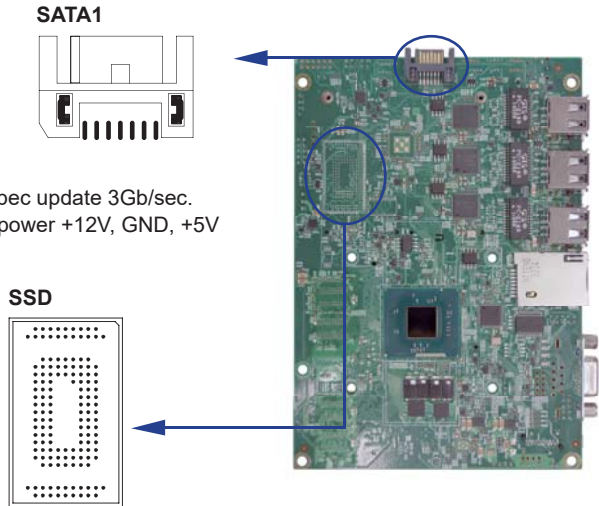

• SSD use SATA port 2 channel

Note: 1. On board SSD for OEM option

3-15 MicroSD Card interface (Socket Push-Push) (Option)

PIN NO.	Description	PIN NO.	Description
1	SDMMC3_D2	2	SDMMC3_D3
3	SDMMC3_CMD	4	+VSDIO
5	SDMMC3_CLK	6	GND
7	SDMMC3_D0	8	SDMMC3_D1
9	SDMMC3_CD_N	10	GND

Note: 1. MicroSD card for OEM option
 2. Use only in WIN8

3-16 Module socket

• Mini card & SIM card

MPCE1/MPCE2: Support USB and PCIe x1 Interface (Mini card socket 52pin)

PIN NO.	Description	PIN NO.	Description
1	NC	2	+3.3V
3	NC	4	GND
5	NC	6	+1.5V
7	NC	8	SIM Power
9	GND	10	SIM Data
11	PCIe-CLK-	12	SIM CLK
13	PCIe-CLK+	14	SIM Reset
15	GND	16	SIM RFU
KEY	KEY	KEY	KEY
17	NC	18	GND
19	NC	20	NC
21	GND	22	RST-
23	PCIe-RX-/mSATA-RX+	24	+3.3V
25	PCIe-RX+/mSATA-RX-	26	GND
27	GND	28	+1.5V
29	GND	30	SMB-CLK
31	PCIe-TX-/mSATA-TX-	32	SMB-DATA
33	PCIe-TX+/mSATA-TX+	34	GND
35	GND	36	USB-DATA-
37	GND	38	USB-DATA+
39	+3.3V	40	GND
41	+3.3V	42	NC
43	NC	44	NC
45	NC	46	NC
47	NC	48	+1.5V
49	NC	50	GND
51	mSATA-Detect	52	+3.3V

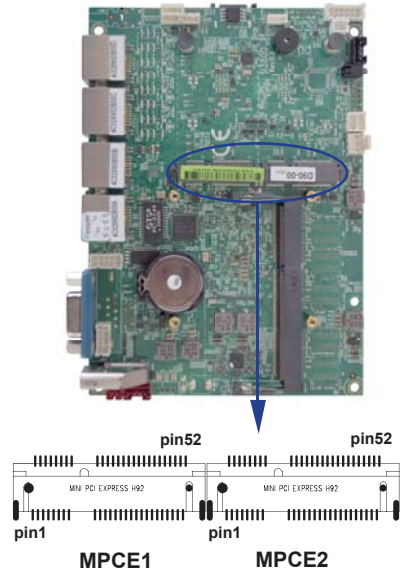

- Note:
1. MPCE1 used SOC-USB port 1(share with CU41)
 2. MPCE1 used PCIe port 4(share with CL4(LAN4))
 3. MPCE2 used HUB-USB port 3(share with CU42)
 4. MPCE1 Pin 8, 10,12,14,16 for SIM1 card reader use.
 5. Just only MPCE2 pin23, 25, 31, 33 supported mSATA device
 6. mSATA use system SATA port 2

3-17 SIM Socket

● SIM1: SIM card socket pin define is follow ISO 7816-2 smart card standard

PIN NO.	Description	PIN NO.	Description
1	VCC	1	GND
2	RST	2	VPP
3	CLK	3	DATA
4	RUF	4	GND

Note: 1. MPCE1 Pin 8, 10,12,14,16 for SIM1 card reader use.

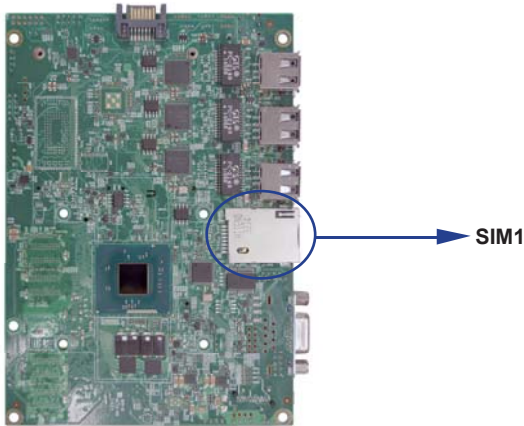

3-18 SODIMM socket (Option)

Note: SODIMM1: SO-DIMM DDR3L 1.35V DRAM Socket

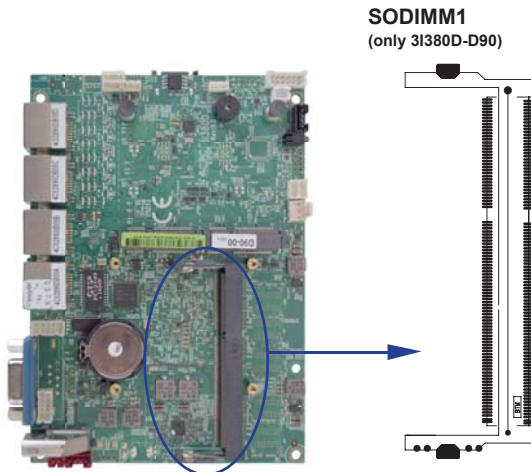

3-19 Connector wafer of Compatible Brand and part number list

Location	CKTS	PITCH	Brand Name	Mating connector	Cable housing
CA1	2x5 10Pin	2.0mm	JST	B10B-PHDSS	PHDR-10VS
CG11	2x5 10Pin	2.0mm	JST	B10B-PHDSS	PHDR-10VS
CC11	2x5 10Pin	2.0mm	JST	B10B-PHDSS	PHDR-10VS
CC2	2x5 10Pin	2.0mm	JST	B10B-PHDSS	PHDR-10VS
CFP1	2x6 12Pin	2.0mm	JST	B12B-PHDSS	PHDR-12VS
CIO1	2x5 10Pin	2.0mm	JST	B10B-PHDSS	PHDR-10VS
CL31	2x4 8Pin	2.0mm	JST	B8B-PHDSS	PHDR-08VS
CL41	2x4 8Pin	2.0mm	JST	B8B-PHDSS	PHDR-08VS
CL32	1x4 4Pin	1.25mm	MOLEX	53047-0410	51021-0400
CL44	1x4 4Pin	1.25mm	MOLEX	53047-0410	51021-0400
CO1	1x4 4Pin	1.25mm	MOLEX	53047-0410	51021-0400
CPI1	1x4 4Pin	2.0mm	JST	B4B-PH-KL	PHR-4
CPI2	1x2 2Pin	2.0mm	JST	B2B-PH-KL	PHR-2
CPI11	2x4 8Pin	2.0mm	JST	B8B-PHDSS	PHDR-08VS
CPO1	1x4 4Pin	2.0mm	JST	B4B-PH-KL	PHR-4
SWP2	1x2 2Pin	2.0mm	JST	B2B-PH-KL	PHR-2
FAN1	1x3 3Pin	2.54mm	MOLEX	7879-3	7880-3
CKM1	1x6 6Pin	1.25mm	MOLEX	53047-0610	51021-0600
CU41	1x4 4Pin	1.25mm	MOLEX	53047-0410	51021-0400
CU42	1x4 4Pin	1.25mm	MOLEX	53047-0410	51021-0400
CU43	1x4 4Pin	1.25mm	MOLEX	53047-0410	51021-0400
CU44	1x4 4Pin	1.25mm	MOLEX	53047-0410	51021-0400
CU5	1x5 5Pin	1.25mm	MOLEX	53047-0510	51021-0500

Chapter-4

Introduction of BIOS

The BIOS is a program located in the Flash Memory on the motherboard.

This program is a bridge between motherboard and operating system.

When you start the computer, the BIOS program gains control.

The BIOS first operates an auto-diagnostic test called POST (Power on Self Test) for all the necessary hardware, it detects the entire hardware devices and configures the parameters of the hardware synchronization. After these tasks are completed, BIOS will give control of the computer back to operating system (OS).

Since the BIOS is the only channel for

hardware and software to communicate with, it is the key factor of system stability and of ensuring your system performance at best.

In the BIOS Setup main menu, you can see several options. We will explain these options in the following pages. First, let us see the function keys you may use here:

Press <Esc> to quit the BIOS Setup.

Press ↑↓←→(up, down, left, right) to choose the option you want to confirm or modify.

Press <F10> to save these parameters and to exit the BIOS Setup menu after you complete the setup of BIOS parameters.

Press Page Up/Page Down or +/- keys to modify the BIOS parameters for the active option.

4-1 Enter Setup

Power on the computer and press key immediately to enter Setup.

If the message disappears before your respond but you still wish to enter Setup, restart the system by turning it OFF then ON or pressing the "RESET" button on the system case. You may also restart the system by simultaneously pressing <Ctrl>, <Alt> and <Delete> keys.

4-2 BIOS Menu Screen & Function Keys

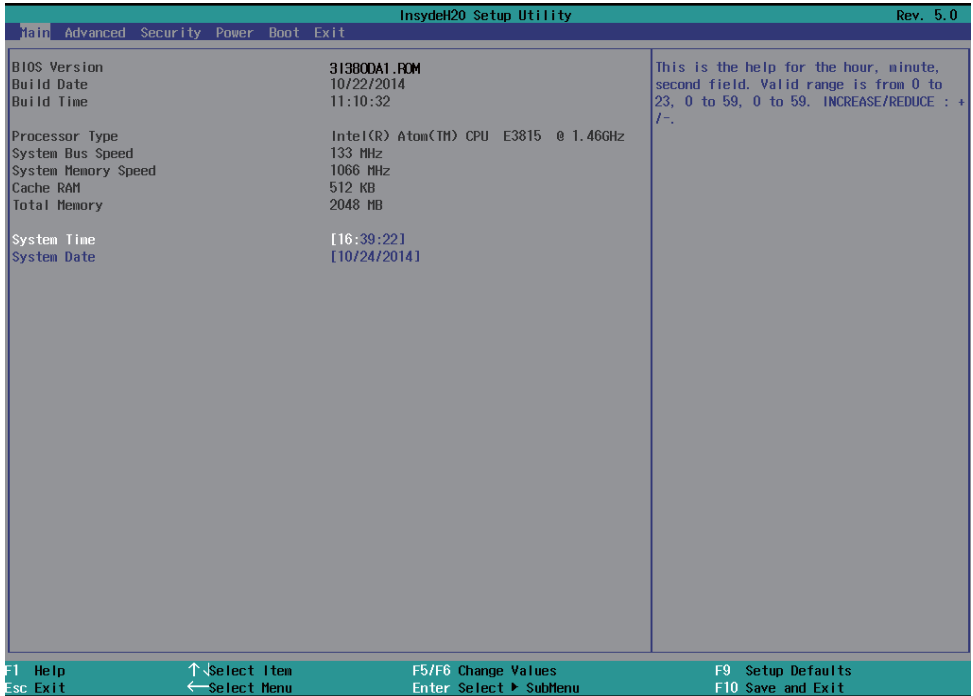

In the above BIOS Setup main menu of, you can see several options.

We will explain these options step by step in the following pages of this

chapter, but let us first see a short description of the function keys you may use here:

- Press ←→ (left, right) to select screen;
- Press ↑↓ (up, down) to choose, in the main menu, the option you want to confirm or to modify.
- Press <Enter> to select.
- Press <+>/<-> or <F5>/<F6> keys when you want to modify the BIOS parameters for the active option.
- [F1]: General help.
- [F9]: Optimized defaults.
- [F10]: Save & Exit.
- Press <Esc> to quit the BIOS Setup.

4-3 General Help

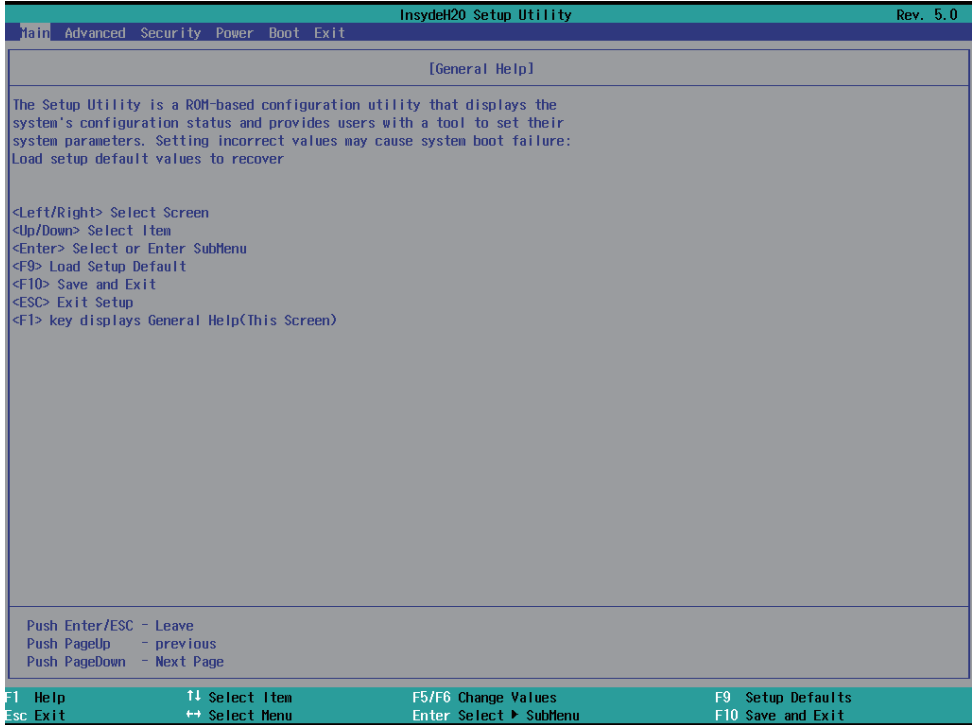

Status Page Setup Menu/ Option Page Setup Menu

Press F1 to pop up a help window that describes the appropriate keys to use and the possible selections for the highlighted item. To exit the Help Window, press <Esc>

4-4 Menu Bars

There are six menu bars on top of BIOS screen:

- Main** To change system basic configuration
- Advanced** To change system advanced configuration
- Security** Password settings
- Power** PME & Power button settings
- Boot Exit** Save setting, loading and exit options.

User can press the right or left arrow key on the keyboard to switch from menu bar.

The selected one is highlighted.

4-5 Main

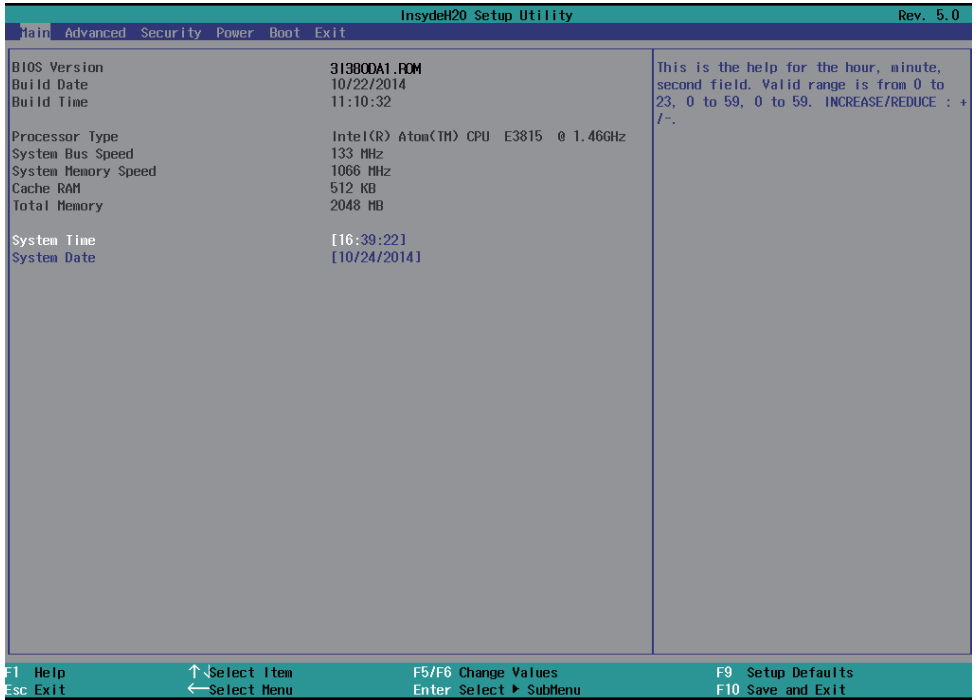

Main menu screen includes some basic system information. Highlight the item and then use the <+> or <-> and numerical keyboard keys to select the value you want in each item.

System Date

Set the Date. Please use [Tab] to switch between data elements.

System Time

Set the Time. Please use [Tab] to switch between data elements.

4-6 Advanced

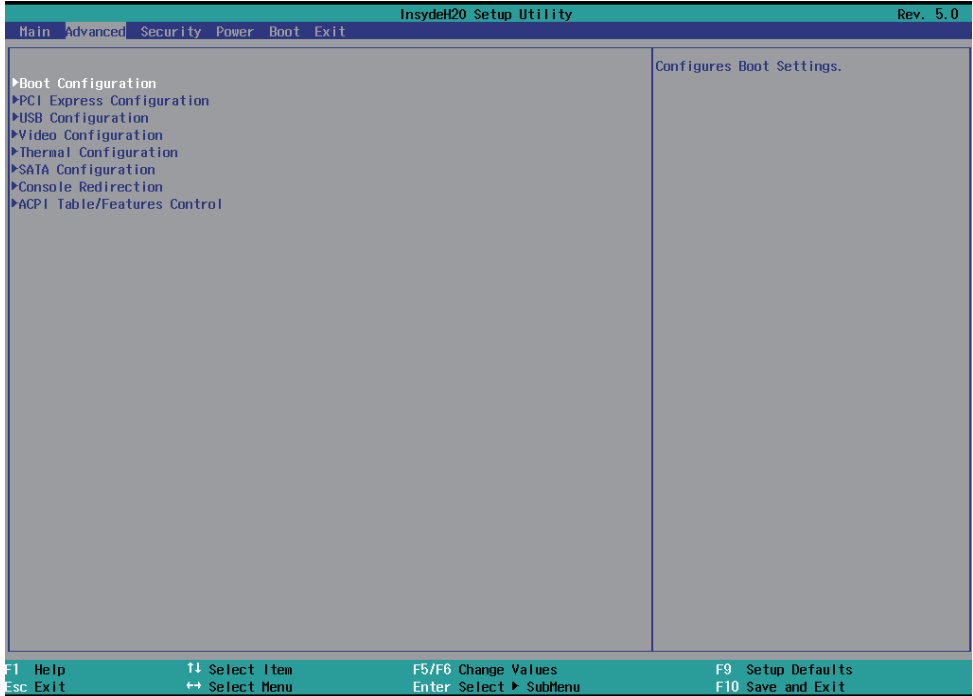

Boot Configuration

Please refer section 4-6-1

PCI Express Configuration

Please refer section 4-6-2

USB Configuration

Please refer section 4-6-3

Video Configuration

Please refer section 4-6-4

Thermal Configuration

Please refer section 4-6-5

SATA Configuration

Please refer section 4-6-6

Console Redirection

Please refer section 4-6-7

ACPI Table/Features Control

Please refer section 4-6-8

4-6-1 Boot Configuration

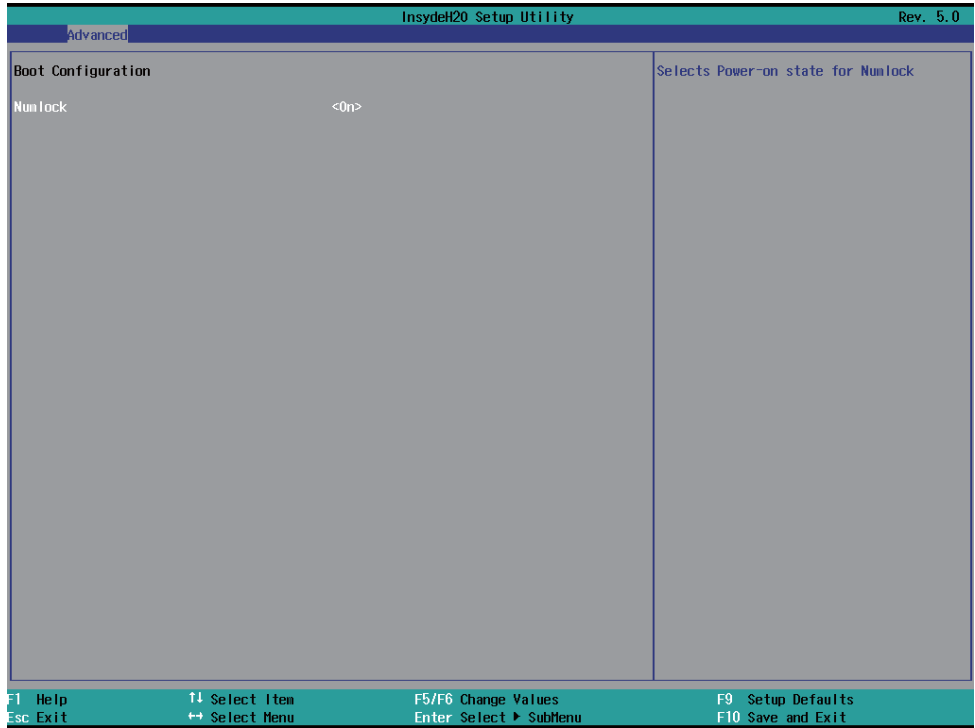

Numlock

Select Power-on state for Numlock, default is <ON>

4-6-2 PCI Express Configuration

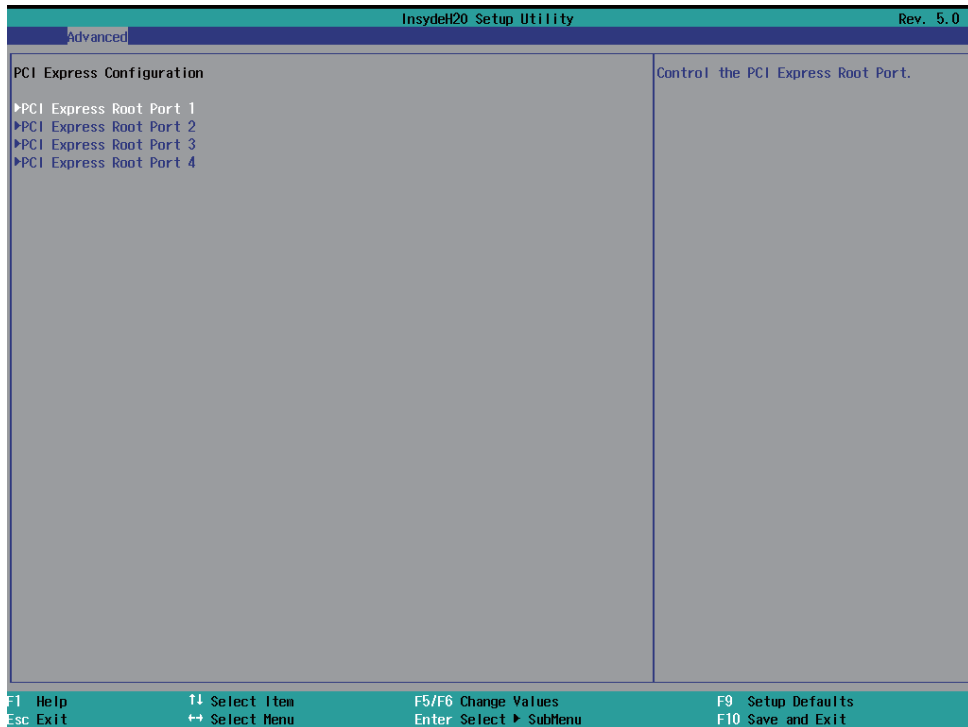

PCIe 1/2/3/4 configuration settings

4-6-2-1 ► PCI Express Root Port 1/2/3/4

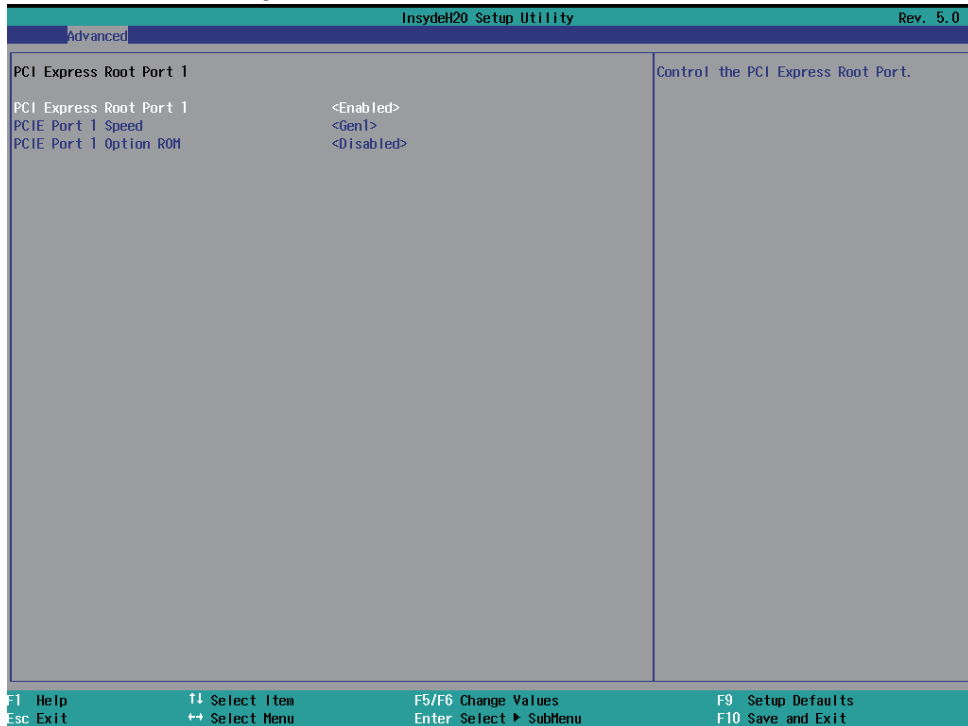

Control the PCI Express Root Port.

The optional settings are: Enabled(default), Disabled.

4-6-2-2 ► PCIE Port 1/2/3/4 Speed

The screenshot shows the InsydeH20 Setup Utility interface. At the top, the title bar reads "InsydeH20 Setup Utility" and "Rev. 5.0". Below the title bar, the "Advanced" menu is selected. The main area is divided into two panels. The left panel, titled "PCI Express Root Port 1", lists the following settings: "PCI Express Root Port 1" (set to <Enabled>), "PCIE Port 1 Speed" (set to <Gen1>), and "PCIE Port 1 Option ROM" (set to <Disabled>). The right panel, titled "Configure PCIE Speed", is currently empty. A blue selection box is positioned over the "Gen1" option in the "Configure PCIE Speed" panel. At the bottom of the screen, a teal status bar contains the following keyboard shortcuts: F1 Help, Esc Exit, ↑ Select Item, ↔ Select Menu, F5/F6 Change Values, Enter Select ► Submenu, F9 Setup Defaults, and F10 Save and Exit.

Select PCI Express port speed.

The optional settings are: Gen1(default), Gen2

4-6-2-3 ► PCIE Port 1/2/3/4 Option ROM

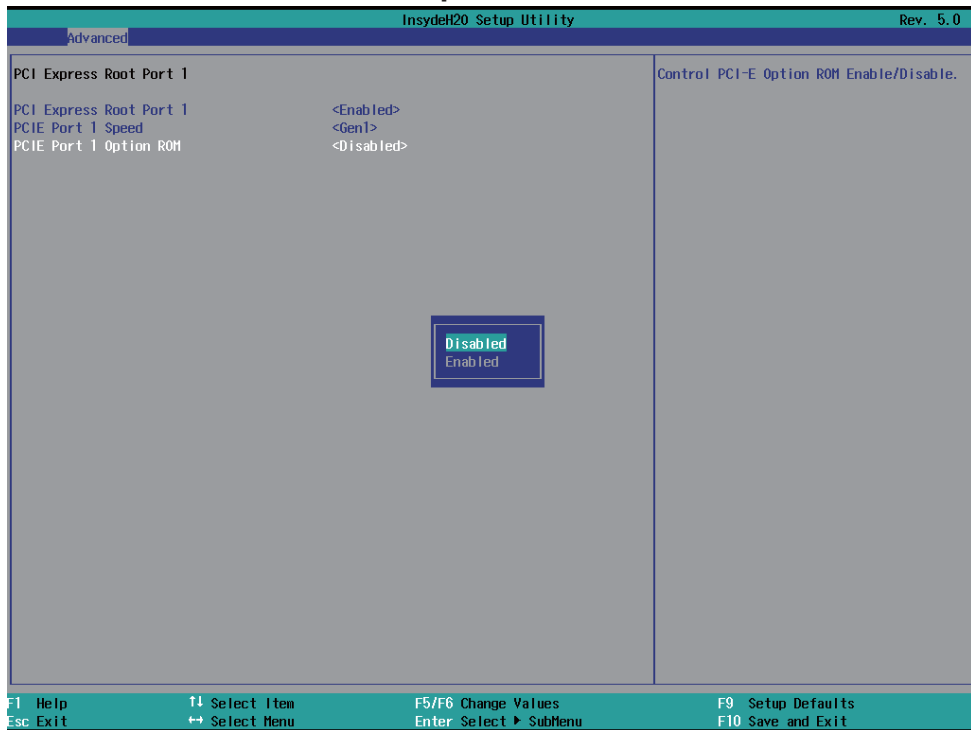

Select PCIE TXE ROM support

The optional settings are: Disabled(default), Enabled

4-6-3 USB Configuration

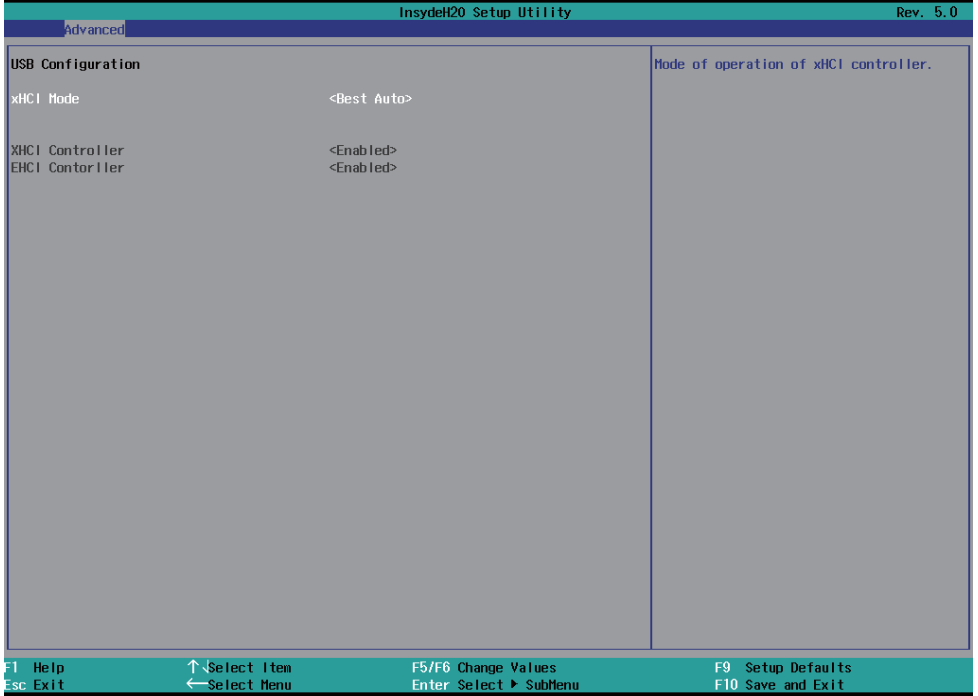

XHCI Mode

Mode of operation of xHCI controller.

The optional settings are: Best Auto(default), Enabled, Disabled.

4-6-4 Video Configuration

Advanced		InsydeH20 Setup Utility		Rev. 5.0	
Video Configuration		Configuration Logo & Setup Utility		Resolution	
Logo & SCU Resolution	<1024 x 768>				
PAVC	<LITE Mode>				
Aperture Size	<256MB>				
IGD - DVMT Pre-Allocated	<64M>				
IGD - DVMT Total Gfx Mem	<256M>				
F1 Help	↑ Select Item	F5/F6 Change Values	F9 Setup Defaults		
Esc Exit	← Select Menu	Enter Select ▶ Submenu	F10 Save and Exit		

Logo & SCU Resolution 1024 x 768(Default) , 800 x 600 , 640 x480

PAVC

The function is setting the display quality,

The optional settings are: Disabled, LITE Mode(default), SERPENT Mode

Aperture Size

The optional settings are: 128MB, 256MB(default), 512MB.

IGD - DVMT Pre-Allocated

Use this item to select DVMT 5.0 pre-allocated (fixed) graphics memory size used by the internal graphics device.

The optional settings are:

64(default)/96/128/160/192/224/256/288/320/352/384/416/448/480/512MB

IGD - DVMT Total Gfx Mem

Use this item to select DVMT 5.0 total graphics memory size used by the internal graphics device.

The optional settings are:128M, 256M(default), MAX

4-6-5 Thermal Configuration

InsydeH20 Setup Utility		Rev. 5.0	
Advanced			
Thermal Configuration Parameters			
Critical Trip Point	<110 °C>		
Passive Trip Point	<105 °C>		
	This value controls the temperature of the ACPI Critical Trip Point - the point in which the OS will shut the system off.		
	NOTE: 100C is the Plan Of Record (POR) for all Intel mobile processors.		
F1 Help	↑ Select Item	F5/F6 Change Values	F9 Setup Defaults
Esc Exit	↔ Select Menu	Enter Select ► SubMenu	F10 Save and Exit

Thermal Configuration Parameters

This Value controls the temperature of the ACPI Critical Trip Point, the point in which the OS will shutdown the system.

Critical Trip point is the shutdown temperature, the default value is 110°

The CPU frequency will auto reduce when cpu temperature arrived to passive Trip point.

The default of the passive trip point is 105°

Note : For BIOS 3I380DDX.ROM

Critical Trip point is the shutdown temperature, the default value is 105°

The CPU frequency will auto reduce when cpu temperature arrived to passive Trip point.

The default of the passive trip point is 100°

4-6-6 SATA Configuration

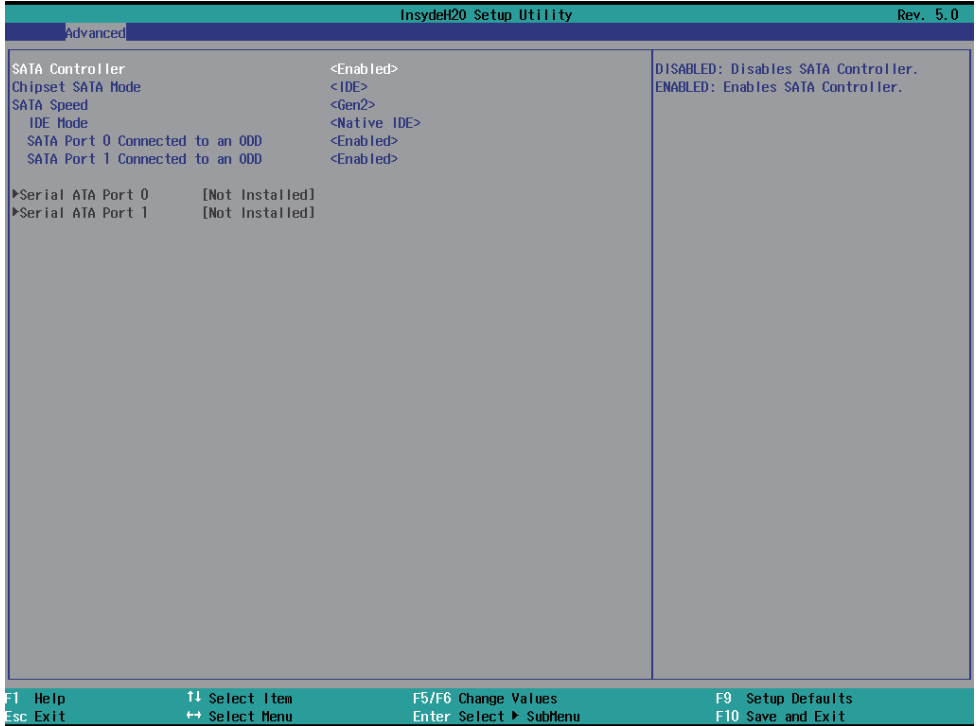

SATA Controller

Use this item to Enable or Disable SATA Device.

The optional settings are: Enabled(default) or Disabled

Chipset SATA Mode

Determine how SATA controller(s) operate.

The optional settings are: IDE Mode(default), AHCI Mode.

SATA Speed

Indicates the maximum speed the SATA controller can support.

The optional settings: Gen1, Gen2(default).

IDE Mode

Legacy IDE or Native IDE MODE,

The optional settings: Legacy IDE or Native IDE(default)

SATA Port 0 Connected to an ODD

Use this item to Enable or Disable SATA Port0 ODD function

The optional settings are: Enabled(default) or Disable

SATA Port 1 Connected to an ODD

Use this item to Enable or Disable SATA Port1 ODD function

The optional settings are: Enabled(default) or Disable

4-6-7 Console Redirection

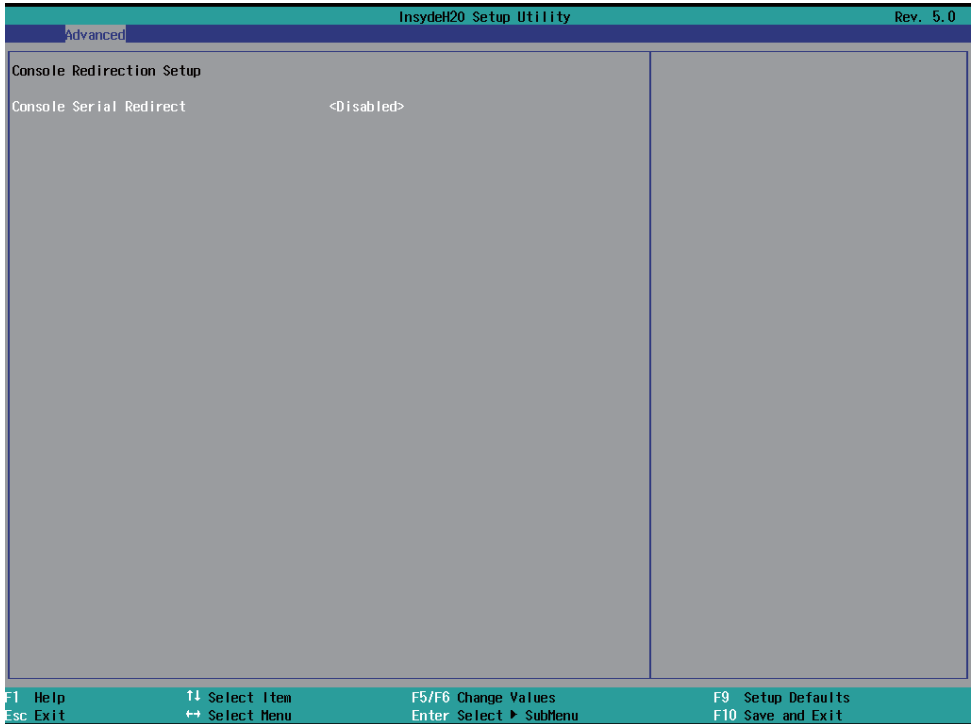

Console Serial Redirect

Use this item to enable or disable Console Redirection.

The optional settings are: Enabled, Disabled(default).

Text Mode Resolution

The optional settings are: Force 80x25

Force 80x24(DEL FIRST ROW)

Force 80x24(DEL LAST ROW)

Baud Rate

The optional settings are: 115200(default) , 57600 , 38400 , 19200 , 9600 , 4800 , 2400 , 1200

Data Bits

The optional settings are: 8 Bits(default) , 7 Bits

Parity

The optional settings are: None(default) , Even , Odd

Stop Bits

The optional settings are: 1 Bit(default) , 2 Bits

Flow Control

The optional settings are: None(default) , RTS/CTS , XON/XOFF

4-6-8 ACPI Table/Features Control

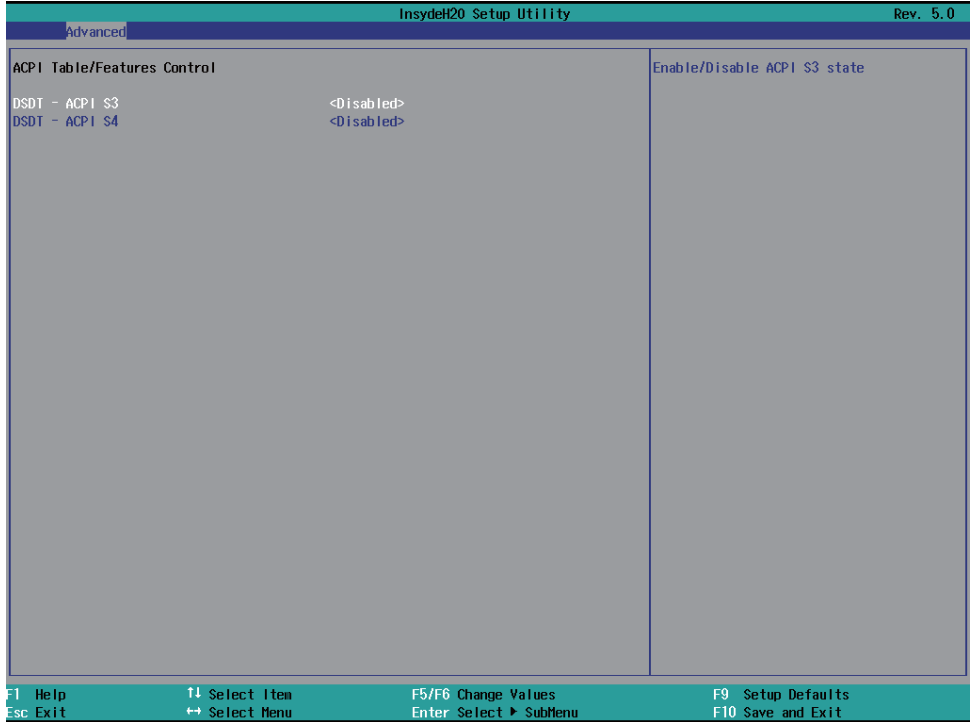

ACPI Table/Features Control

Select ACPI sleep state the system will enter when the SUSPEND button is pressed.

The optional settings: DSDT - ACPI S3 (Suspend to RAM), Enabled or Disabled(default)

DSDT - ACPI S4 (Suspend to Disk), Enabled or Disabled(default)

4-7 Security

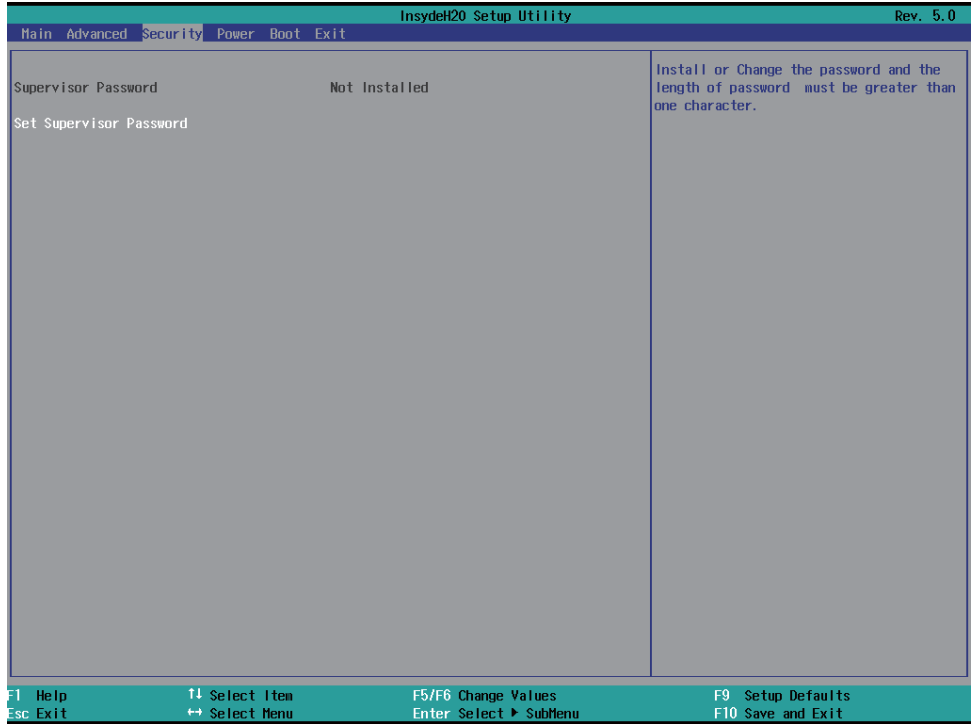

Supervisor Password

To set up an Supervisor password

1. Select Supervisor Password.

The screen then pops up an Create New Password dialog.

2. Enter your desired password that is no less than 3 characters and no more than 10 characters.
3. Hit [Enter] key to submit.

4-8 Power

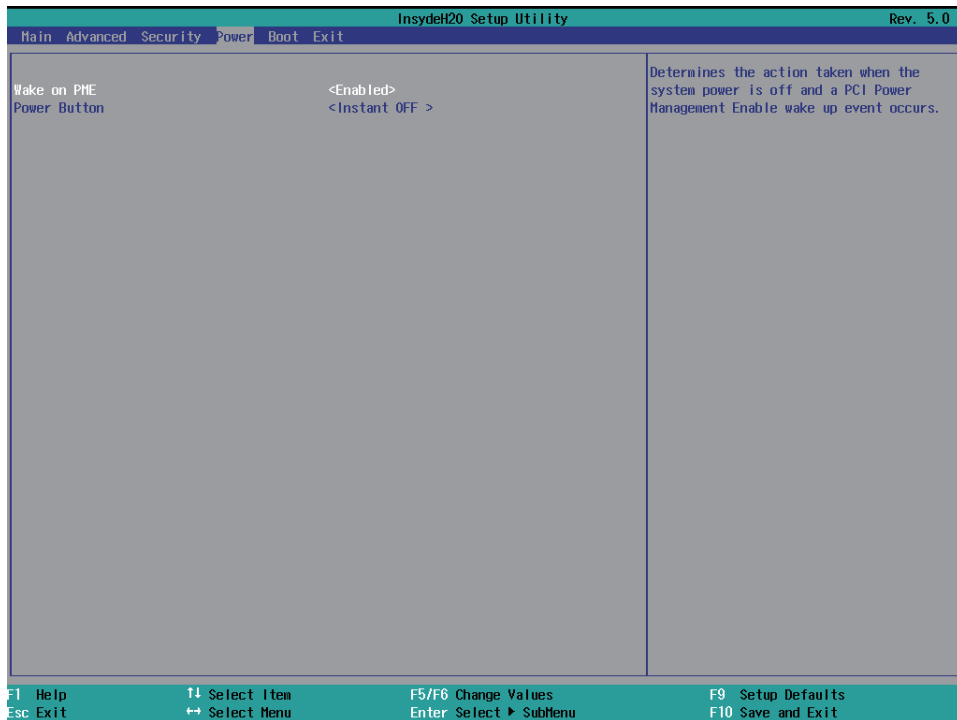

Wake on PME

Determines the action taken when the system power is off and the PCI power management Enable wake up event occurs.

The optional settings: Enabled, Disabled(default)

Power Button

Instant OFF(default) : The system will be turn off directly when push the power button.

Delay 4 sec : The system will be turn off when push the power button for 4 sec.

4-9 Boot



Boot type

Select boot type for Dual type ,Legacy boot type or UEFI boot type, default is Dual boot type

Quiet Boot

The optional settings are: Enabled(default), Disabled.

EFI / Legacy Device order

Determine EFI device first or legacy device first.

The optional settings: EFI device first, Legacy device first(default), smart mode

4-9-1 Legacy

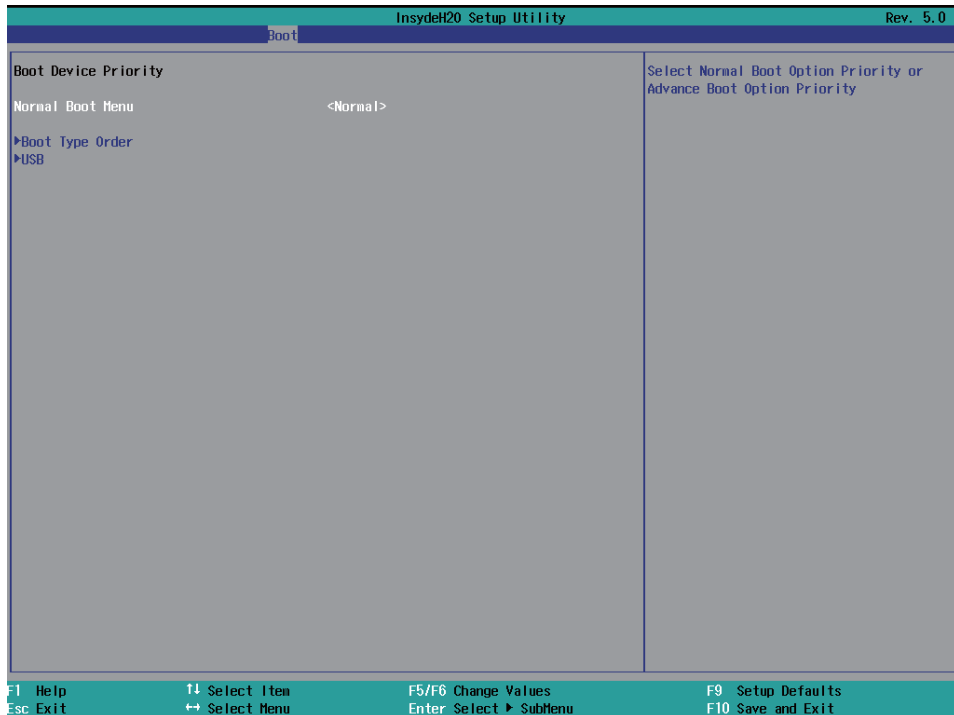

Normal Boot Menu

Select Normal Boot option priority or Advance Boot option priority.

The optional settings: Normal(default), Advance

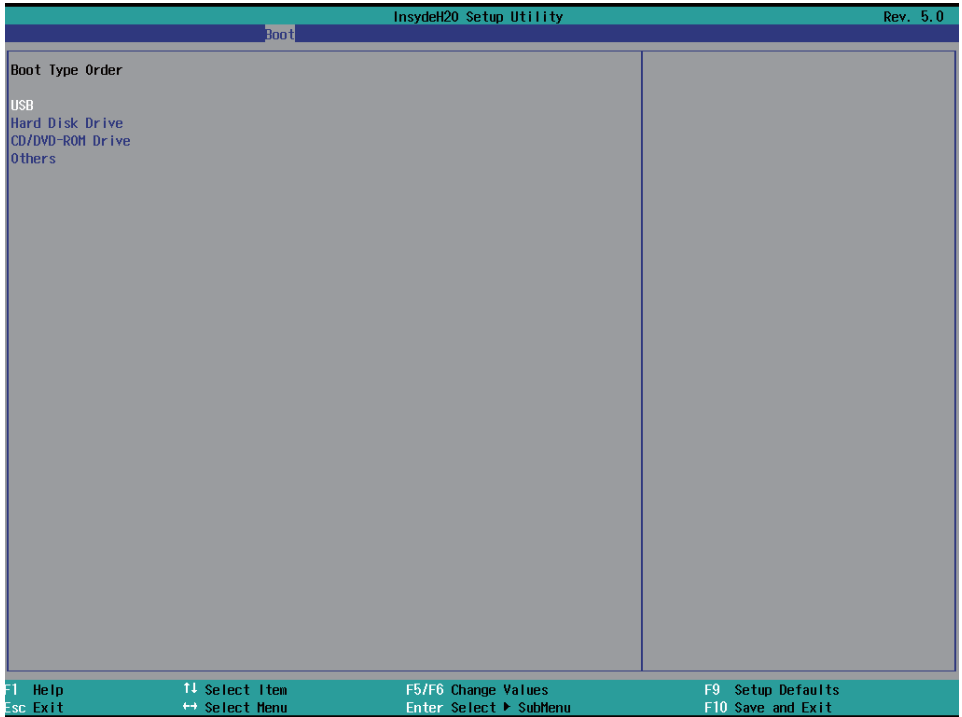

Boot Type Order

Setting the boot type priority.

The default settings is 1.USB drive 2.Hard Disk Drive 3.CD/DVD ROM drive 4.Others

4-10 EXIT

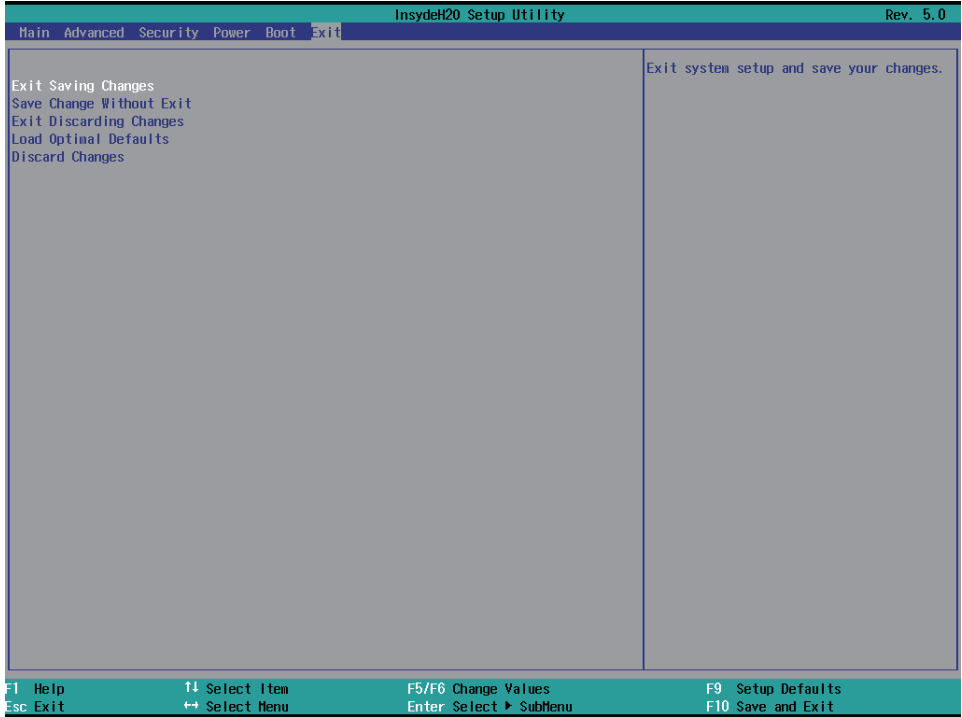

Exit Saving Changes

This item allows user to reset the system after saving the changes.

Save Change Without Exit

This item allows user to saving the changes but doesn't restart.

Exit Discard Changes

This item allows user restart the system but no saving the changes

Load Optimal Default

Use this item to restore the optimal default for all the setup options.

Discare Changes

Use this item to cancel all the setup options.

4-11 Device Manager

Please press the key F10 when bootup to go into the Device Manager menu



Serial Port 1/2 Configuration

Please refer section 4-11-1

4-11-1 SIO FINTEK81801U

SIO FINTEK81801U		
Serial Port 1	<Enable>	Configure Serial port using options : [Disable] No Configuration [Enable] User Configuration [Auto] EFI/OS chooses configuration
Base I/O Address	<3F8>	
Interrupt	<IRQ4>	
Serial Mode	<RS232 driver>	
Serial Port 2	<Enable>	
Base I/O Address	<2F8>	
Interrupt	<IRQ3>	
Serial Mode	<RS232 driver>	
Power Fail	<Keep State>	
Hardware Monitor		
↑↓=Move Highlight F9=Reset to Defaults F10=Save <Enter>=Select Entry Esc=Discard Changes		

Serial Port 1/2

Use this item to enable or disable serial port (COM1,COM2)
The optional settings are: Enabled(default), Disabled.

Serial Port 1 Base IO Address / Interrupt / Serial Mode

Use this item to select an optimal setting for super IO device.

The optional settings are:

IO=3F8h; IRQ=4 (default)

IO=3F8h; IRQ=3,4

IO=2E8h; IRQ=3,4

IO=2F8h; IRQ=3,4

IO=3E8h; IRQ=3,4

Serial Port 2 Base IO Address / Interrupt / Serial Mode

Use this item to select an optimal setting for super IO device.

The optional settings are:

IO=2F8h; IRQ=3 (default)

IO=3F8h; IRQ=3,4

IO=2E8h; IRQ=3,4

IO=2F8h; IRQ=3,4

IO=3E8h; IRQ=3,4

Serial Mode

RS232 driver(default) :

When hardware select to RS232 or RS422 mode, please enter to RS232 driver.

RS485 driver: When hardware select to RS485 mode, please enter to RS485 driver. It is the auto flow function for RS485.

Power Failure

This item specifies whether your system will reboot after a power failure or interrupt occurs.

[Keep state] Restores the system to the status before power failure or interrupt occurred. (default)

[Always on] Leaves the computer in the power on state.

[Always off] Leaves the computer in the power off state.

Hardware Monitor

Hardware Monitor	
Hardware Monitor	
Voltage	
VCC3	3.392 V
VCORE	0.792 V
VGFX	0.856 V
Temperature	
CPU (°C/°F)	52°C/125°F
System (°C/°F)	50°C/122°F
Fan Speed	
FAN SPEED	0 RPM

Press [Enter] to view PC health status.

This section shows the status of your CPU, Fan, and overall system.

This is only available when there is Hardware Monitor function onboard.

Chapter-5

DRIVER INSTALLATION

There is a system installation DVD in the package. This DVD does not only include all the drivers you need but also some other free application programs and utility programs. In addition, this DVD also includes an auto detect software telling you which hardware is installed and which driver is needed so that your system can function properly. We call this auto detect software SYSTEM INSTALL.

SYSTEM INSTALL Supports Windows 7(32bit/64bit) / Windows 8/8.1(32bit/64bit)

Insert the DVD into your DVD-ROM drive and the SYSTEM INSTALL menu should appear as below. If the menu does not appear, double-click MY COMPUTER and double-click DVD-ROM drive or click START, click RUN, and type X:\SETUP.EXE (assuming your DVD-ROM drive is X).

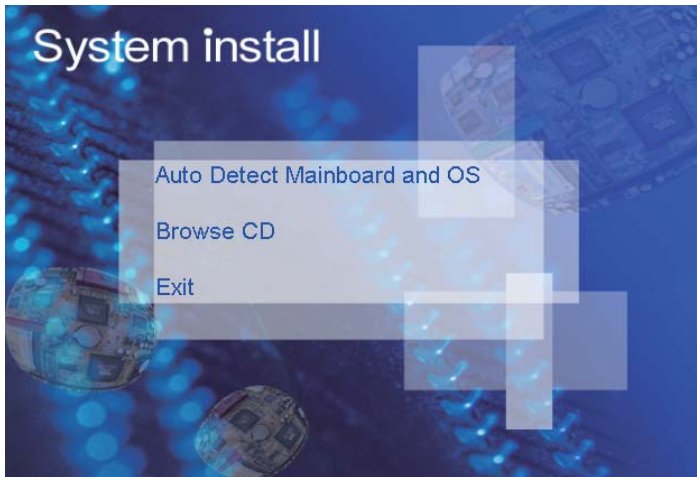

Make your selection from SYSTEM INSTALL menu:

1. Auto Detect Main board and OS to AUTOMATIC DRIVER INSTALLATION menu
2. Browse DVD to view the contents of the DVD
3. Exit to exit SYSTEM INSTALL menu

AUTOMATIC DRIVER INSTALLATION menu

Bay Trail for Windows 8.1 (x64)

- | | |
|-------------|--------|
| 1. INF | 4. LAN |
| 2. VGA | 5. TXE |
| 3. HD Audio | 6. MBI |

Back to previous page

- | | |
|--------------|--|
| 1. INF | Install Intel Baytrail chipset driver |
| 2. VGA | Install onboard VGA driver |
| 3. Serial IO | Install Serial IO driver (FOR Win 7 only) |
| 4. xHCI | Install Intel USB 3.0 xHCI driver (FOR Win 7 only) |
| 5. HD Audio | Install HD Audio Codec driver |
| 6. MBI | Install MBI driver (FOR Win 8/8.1 only) |
| 7. LAN | To the LAN driver Readme file |
| 8. TXE Patch | Install Intel TXE patch (FOR Win 7 only) |
| 9. TXE | Install Intel TXE driver |

Each selection is illustrated below:

5-1 INF Install Intel Baytrail Chipset Driver (example for WIN8 64bit)

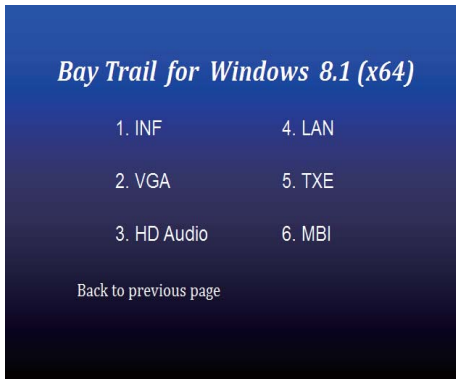

1. At the "AUTOMATIC DRIVER INSTALLATION menu" screen, click "INF".



2. At the "Intel® Chipset Device Software" screen, click "Next".



3. At the "License Agreement" screen, click "Yes"



4. At the "Readme File Information" screen, Click "Next".



5. Click "Next"



6. Click "Finish" & restart computer.

NOTE: SYSTEM INSTALL will auto detect file path

For Windows 7 64/32-bit,

X:\driver\INTEL\BAY\INF\WIN7\infinst_autol.exe

For Windows 8 / 8.1 32/64-bit

X:\driver\INTEL\BAY\INF\WIN_8_64\infinst_autol.exe

5-2 VGA Install Intel Baytrail VGA Driver (example for WIN8 64bit)

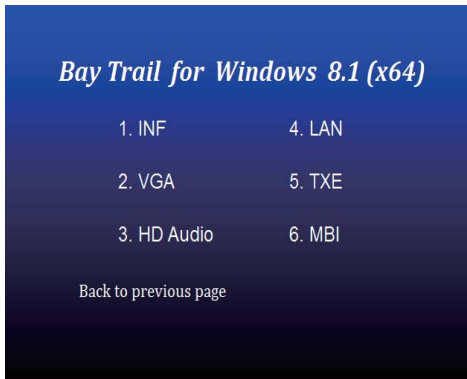

1. At the "AUTOMATIC DRIVER INSTALLATION menu" screen, click "VGA".

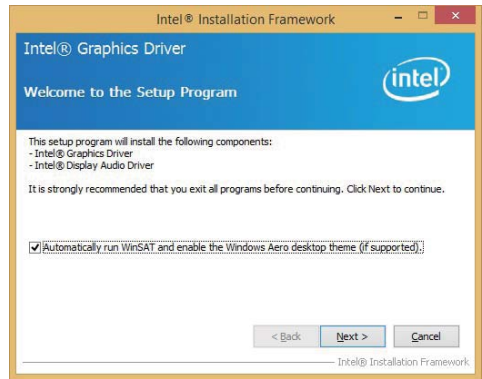

2. At the "Welcome to the Setup Program screen, Click "Next".

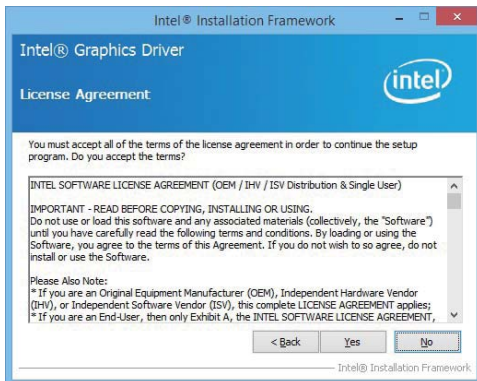

3. At the "License Agreement" screen, Click "Yes"

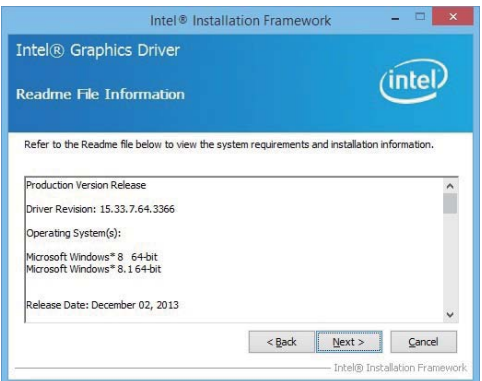

4. At the "Readme File Information" screen, Click "Next"

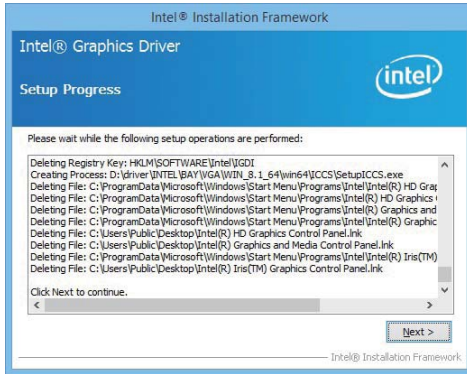

5. At the "Setup Progress" screen,
Click "Next".

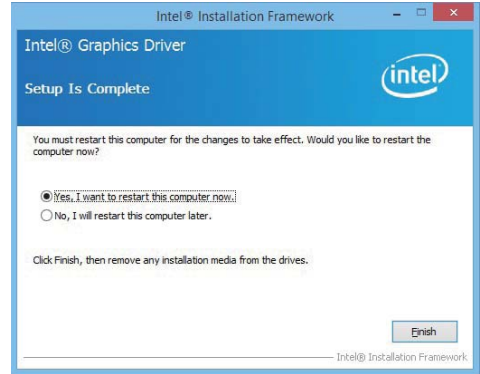

6. Click "Finish" to restart computer

NOTE: SYSTEM INSTALL will auto detect file path

For Windows 7 32-bit,

X:\driver\INTEL\BAY\VGA\WIN_7_32\Setup.exe

For Windows 7 64-bit

X:\driver\INTEL\BAY\VGA\WIN_7_64\Setup.exe

For Windows 8 / Windows 8.1 32-bit

X:\driver\INTEL\BAY\VGA\WIN_8_32\Setup.exe

For Windows 8 / Windows 8.1 64-bit

X:\driver\INTEL\BAY\VGA\WIN_8_64\Setup.exe

5-3 Serial IO Install Driver Baytrail Serial IO Driver (FOR Windows 7 only)



1. At the "AUTOMATIC DRIVER INSTALLATION menu" screen, click "Serial IO".

2. At the "Welcome to the Setup Program screen, Click "Next".

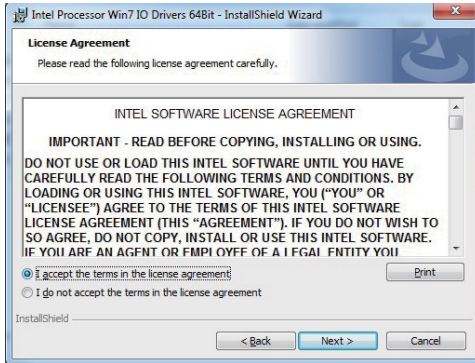

3. At the "License Agreement" screen, Click "Yes"

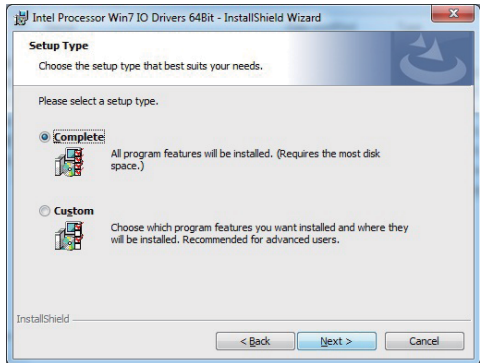

4. At the "Setup type" screen, select "complete" and Click "Next".

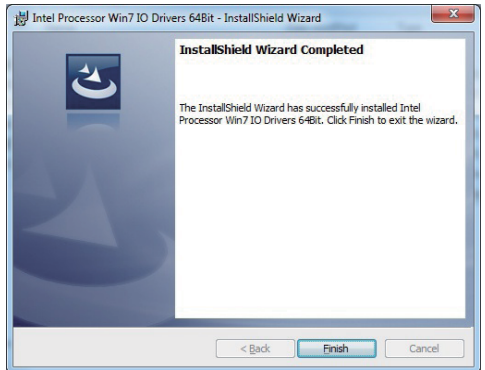
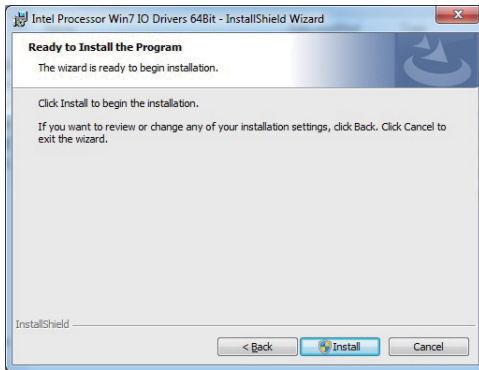

5. At the "Ready to install the program" screen, Click "Install"
6. Click "Finish" and restart computer

NOTE: SYSTEM INSTALL will auto detect file path

For Windows 7 32-bit,

X:\driver\INTEL\BAY\SERIALIO\WIN7_32Bit.msi

For Windows 7 64-bit

X:\driver\INTEL\BAY\SERIALIO\Win7_64Bit.msi

5-4 xHCI Install Intel USB 3.0 xHCI Driver (FOR Windows 7 only)



1. At the "AUTOMATIC DRIVER INSTALLATION menu" screen, click "xHCI".



2. At the "Welcome to the Setup Program screen, Click "Next".

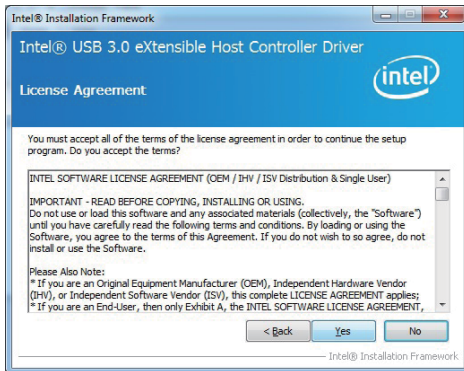

3. At the "License Agreement" screen, Click "Yes".



4. At the "Readme File Information" screen, Click "Next".

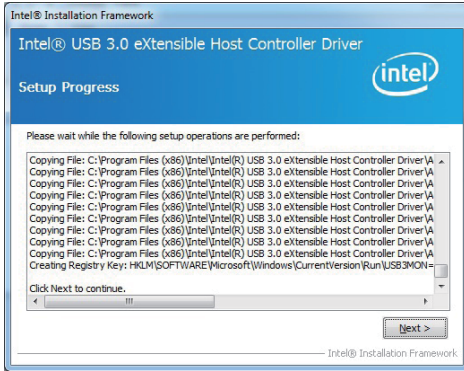

5. At the "Setup Progress" screen, Click "Next". 6. Click "Finish" to restart computer

NOTE: SYSTEM INSTALL will auto detect file path

For Windows 7 32 / 64-bit,

X:\driver\INTEL\BAY\XHCI\Driver_Installer\Setup.exe

5-5 HD Audio Install High Definition Audio Driver (example for WIN8 64bit)

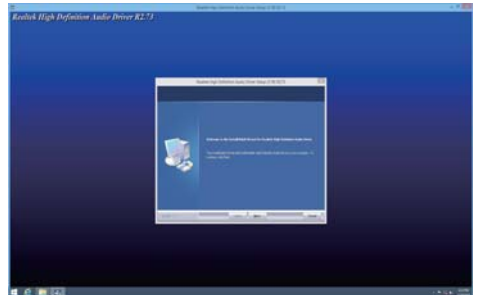

1. At the "AUTOMATIC DRIVER INSTALLATION menu", click "HD Audio"

2. Click "Next".



3. Click "Finish" to restart computer

NOTE: SYSTEM INSTALL will auto detect file path
For Windows 7 32 / 64-bit, Windows 8/8.1 32 / 64-bit
X:\driver\INTEL\BAY\SOUND\Win7_Win8_Win81_R273.exe

5-6 MBI Install Intel MBI Driver (FOR Win 8/8.1 only)

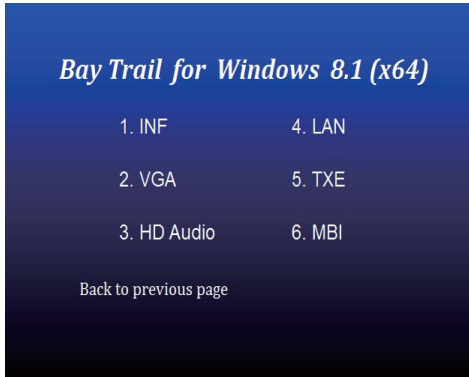

1. At the "AUTOMATIC DRIVER INSTALLATION menu", click "HD Audio".

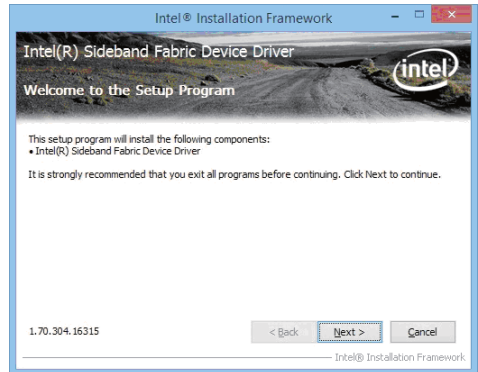

2. At the "Welcome to the Setup Program screen, Click "Next".



3. At the "License Agreement" screen, Click "Yes".

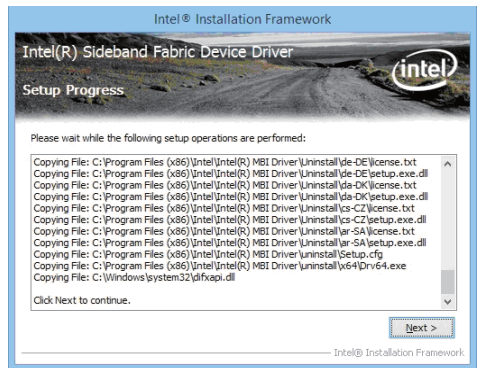

4. At the "Setup Progress" screen, Click "Next".

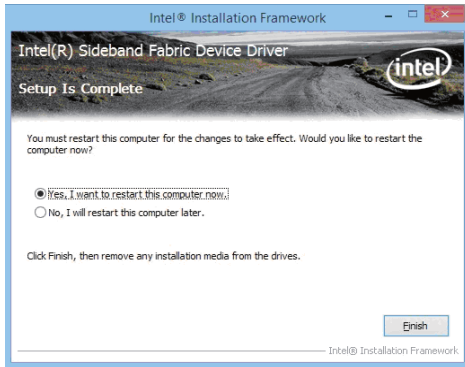

5. Click "Finish" to restart computer

NOTE: SYSTEM INSTALL will auto detect file path

For Windows 8/8.1 32 / 64-bit,

X:\driver\INTEL\BAY\MBI\Setup.exe

5-7 TXE Install Intel TXE driver

5-7-1 TXE Install for WIN8/WIN8.1

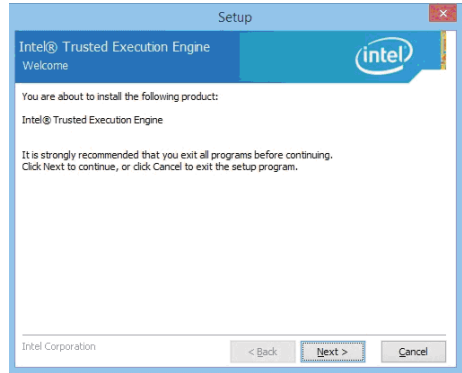

1. At the "AUTOMATIC DRIVER INSTALLATION menu", click "TXE".

2. At the "Setup" screen, Click "Next".

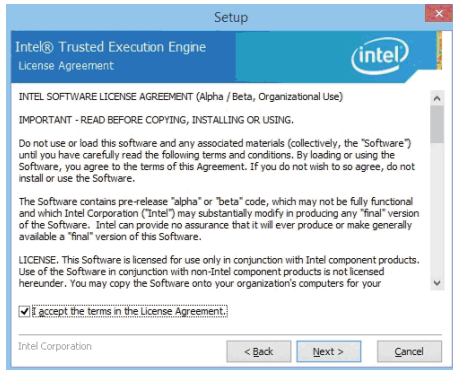

3. At the "License Agreement" screen, Click "Yes".

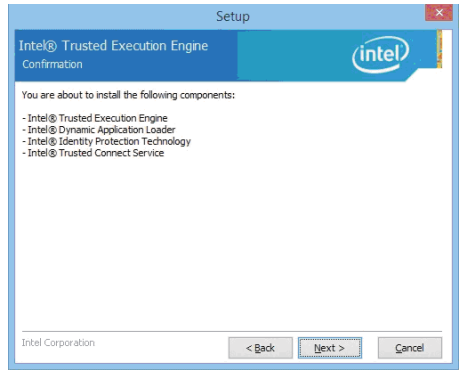

4. Click "Next".

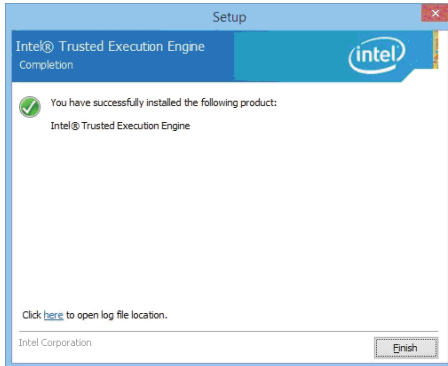

5. Click "Finish" & restart computer

NOTE: SYSTEM INSTALL will auto detect file path

For Windows 8 32 / 64-bit,

X:\driver\INTEL\BAY\TXE\WIN_8\SetupTXE.exe

For Windows 8.1 32 / 64-bit,

X:\driver\INTEL\BAY\TXE\WIN_8.1\SetupTXE.exe

5-7-2 TXE Install for WIN7

Please install PXE Patch first.



1. At the "AUTOMATIC DRIVER INSTALLATION menu", click "TXE Patch".

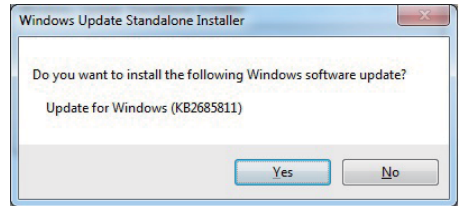

2. At the "Windows Update" screen, Click "Yes".

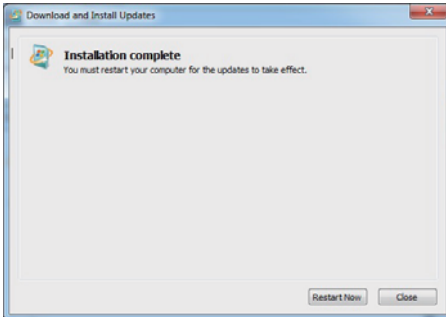

3. Click "Finish" & restart computer

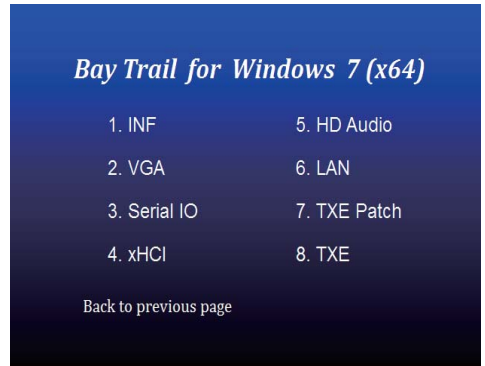

4. At the "AUTOMATIC DRIVER INSTALLATION menu", click "TXE "

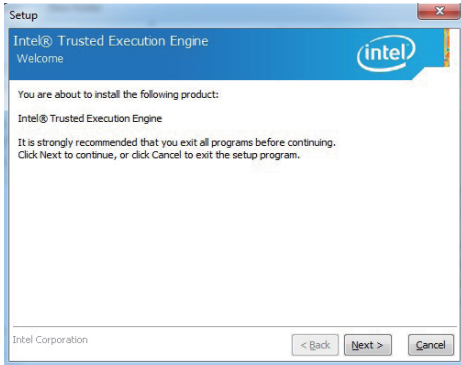

5. At the "TXE Setup" screen, Click "Next".

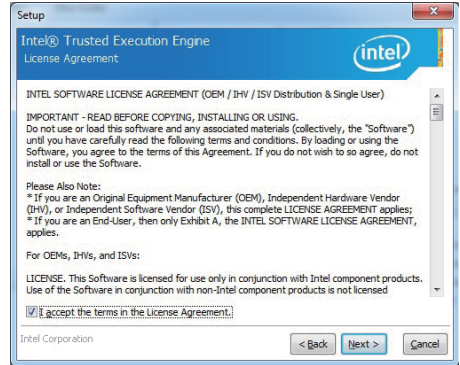

6. At the "License Agreement" screen, Click "Yes".

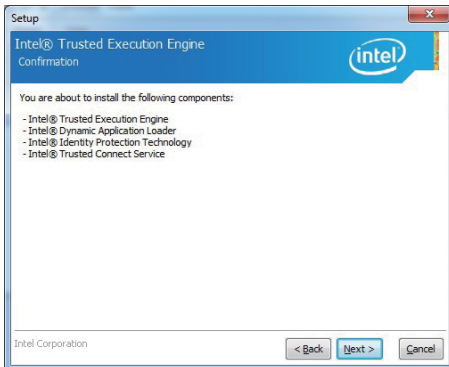

7. Click "Next".

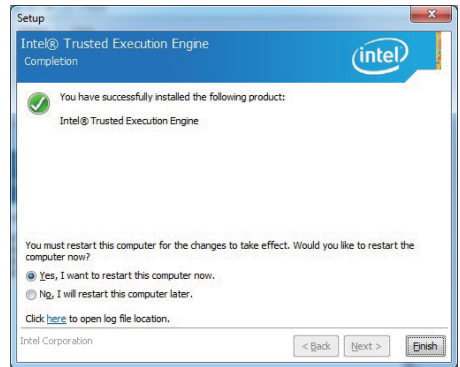

8. Click "Finish" & restart computer

NOTE: SYSTEM INSTALL will auto detect file path

For Windows 7 32 / 64-bit,

TXE Patch

X:\driver\INTEL\BAY\TXE\WIN_7\kmdf-1.11-Win-6.1-x86.msu

X:\driver\INTEL\BAY\TXE\WIN_7\kmdf-1.11-Win-6.1-x64.msu

TXE

X:\driver\INTEL\BAY\TXE\WIN_7\SetupTXE.exe

X:\driver\INTEL\BAY\TXE\WIN_7\SetupTXE.exe

5-8 How to update Insyde BIOS

Under DOS Mode

STEP 1. Prepare a bootable disc.

(Storage device could be USB FDD or USB pen drive.)

STEP 2. Copy utility program to your bootable disc. You may download it from our website.

STEP 3. Copy the latest BIOS for your LEX motherboard from our website to your bootable disc.

STEP 4. (Here take 3I380D as an example, please enter your motherboard's name)

Insert your bootable disc into X: (X could be C:, A: or others.

It depends on which type of storage device you use.)

Start the computer and type

```
X:\> H2OFFT-D.EXE 3I380DA2.ROM -BIOS -ALL
```

3I380DA2.ROM is the file name of the latest BIOS.

It may be 3I380DA1.ROM or 3I380DA2.ROM, etc.

Please leave one space between .ROM & -BIOS -ALL

By Bay Trail series mainboard, please type

```
X:\> H2OFFT-D.EXE 3I380DA2.ROM -BIOS -ALL
```

```
-BIOS : Flash BIOS region
```

```
-ALL : Flash all
```

STEP 5. Press ENTER and the BIOS will be updated,

Computer will restart automatically.

Appendix A: Power Consumption Test

Condition

Item	Spec
CPU	Atom E3815 1.46 Ghz
Memory	DDR3L 1066 2GB
Operating System	Windows 7 / SP1
Test Program	3D Mark 06
HDD 2.5" SATA	Slim Type HDD
mSATA	32GB

Test Result for reference only !

		Power off	Start up		Operation Maximum	Shut down Maximum
			Maximum	Stable		
E3815	Slim Type HDD	0.03A	0.79A	0.5A	0.86A	0.66A
	mSATA	0.03A	0.64A	0.45A	0.73A	0.56A

The power consumption depends on your device choice!

Condition

Item	Spec
CPU	Celeron J1900 2 Ghz
Memory	DDR3L 1333 4GB
Operating System	Windows 7 / SP1
Test Program	3D Mark Vantage
HDD 2.5" SATA	Slim Type HDD
mSATA	32GB

Test Result for reference only !

		Power off	Start up		Operation Maximum	Shut down Maximum
			Maximum	Stable		
J1900	Slim Type HDD	0.03A	0.84A	0.52A	1.31A	0.8A
	mSATA	0.03A	0.79A	0.5A	1.15A	0.68A

The power consumption depends on your device choice!

Appendix B: Resolution list

640 x 480 x (256 / 16bit / 32bit)
800 x 600 x (256 / 16bit / 32bit)
1024 x 768 x (256 / 16bit / 32bit)
1152 x 864 x (256 / 16bit / 32bit)
1280 x 600 x (256 / 16bit / 32bit)
1280 x 720 x (256 / 16bit / 32bit)
1280 x 768 x (256 / 16bit / 32bit)
1280 x 800 x (256 / 16bit / 32bit)
1280 x 960 x (256 / 16bit / 32bit)
1280 x 1024 x (256 / 16bit / 32bit)
1400 x 1050 x (256 / 16bit / 32bit)
1440 x 900 x (256 / 16bit / 32bit)
1600 x 900 x (256 / 16bit / 32bit)
1600 x 1200 x (256 / 16bit / 32bit)
1680 x 1050 x (256 / 16bit / 32bit)
1920 x 1080 x (256 / 16bit / 32bit)
1920 x 1200 x (256 / 16bit / 32bit)

Appendix C: F7511N I²C DIO device

1-1 IO Device: F75111 under Windows

The Sample code source you can download from



Source file: F75111_DIOSrc.rar http://tprd.info/lexwiki/index.php/IO_Device:F75111

Binary file: F75111_DemoBin.rar

USERNAME & PASSWORD: sf

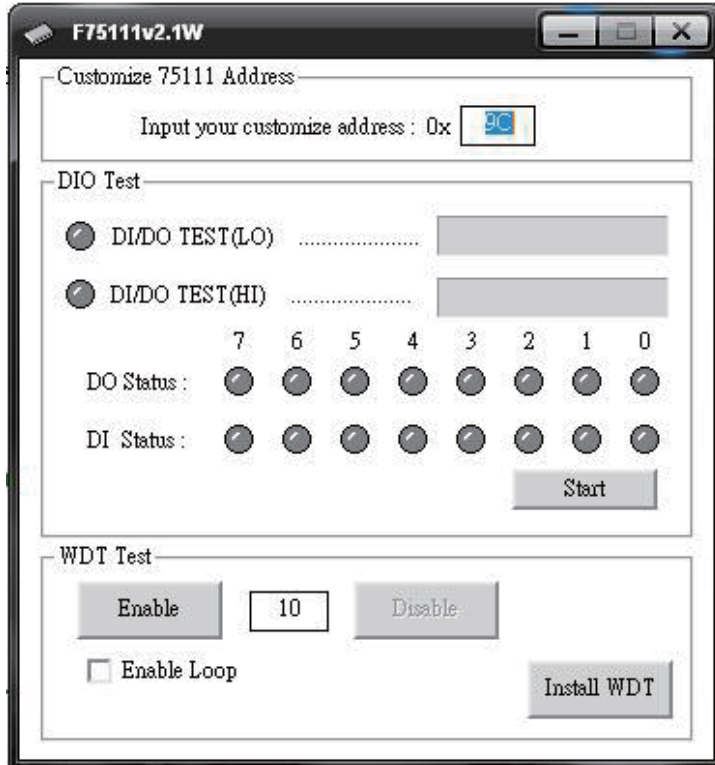
How to use this Demo Application



1. Press the "Start" button to test DIO function
2. Press the "Enable" button to test WDT function
3. Press the "Disable" button to disable WDT
4. Check the "Enable Loop" box and press "Enable" to do WDT loop test
5. Press "Install WDT" to set the system to autorun this application when booting, press again to remove this application when booting.
6. If WDT enable, system icon will be  . if disable, system icon will be 

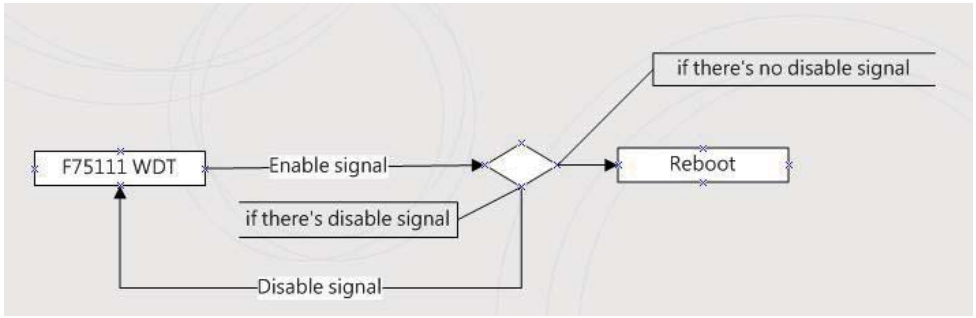

p.s.
 f75111 send "F75111_SetWDTEnable(BYTE byteTimer)" including a parameter "timer",
 if there's no disable signal (F75111_SetWDTDisable()) to stop it before timer countdown to 0, System will reboot.
 if there's disable signal received, resent Enable WDT signal, for a loop to prevent from reboot

Introduction

Initial Internal F75111 port address (0x9c)

```

define GPIO1X, GPIO2X, GPIO3X to input or output
and Enable WDT function pin
  
```

Set F75111 DI/DO (sample code as below Get Input value/Set output value)

```

DO: InterDigitalOutput(BYTE byteValue)
DI: InterDigitalInput()
  
```

Enable/Disable WDT

```

Enable : F75111_SetWDTEnable (BYTE byteTimer)
Disable: F75111_SetWDTDisable ()
  
```

PULSE mode

Sample to setting GP33, 32, 31, 30 output 1mS low pulse signal.

```

{
this->Write_Byte(F75111_INTERNAL_ADDR, GPIO3X_PULSE_CONTROL,      0x00); //This is setting low pulse output
this->Write_Byte(F75111_INTERNAL_ADDR, GPIO3X_PULSE_WIDTH_CONTROL, 0x01); //This selects the pulse width to 1mS
this->Write_Byte(F75111_INTERNAL_ADDR, GPIO3X_CONTROL_MODE,       0x0F); //This is setting the GP33, 32, 31, 30 to output function.
this->Write_Byte(F75111_INTERNAL_ADDR, GPIO3X_Output_Data ,       0x0F); //This is setting the GP33, 32, 31, 30 output data.
}
  
```

Sample to setting GP33, 32, 31, 30 output 1mS low pulse signal.

```

void F75111::InitInternalF75111()
{
this->Write_Byte(F75111_INTERNAL_ADDR,GPIO1X_CONTROL_MODE ,0x00); //set GPIO1X to Input function
this->Write_Byte(F75111_INTERNAL_ADDR,GPIO3X_CONTROL_MODE ,0x00); //set GPIO3X to Input function
this->Write_Byte(F75111_INTERNAL_ADDR,GPIO2X_CONTROL_MODE ,0xFF); //set GPIO2X to Output function

this->Write_Byte(F75111_INTERNAL_ADDR,F75111_CONFIGURATION ,0x03); //Enable WDT OUT function
}
  
```

Set output value

```
void F75111::InterDigitalOutput(BYTE byteValue)
{
    BYTE byteData = 0;
    byteData = (byteData & 0x01 )? byteValue + 0x01 : byteValue;
    byteData = (byteData & 0x02 )? byteValue + 0x02 : byteValue;
    byteData = (byteData & 0x04 )? byteValue + 0x04 : byteValue;
    byteData = (byteData & 0x08 )? byteValue + 0x08 : byteValue;
    byteData = (byteData & 0x10 )? byteValue + 0x10 : byteValue;
    byteData = (byteData & 0x20 )? byteValue + 0x20 : byteValue;
    byteData = (byteData & 0x40 )? byteValue + 0x40 : byteValue;
    byteData = (byteData & 0x80 )? byteValue + 0x80 : byteValue;           // get value bit by bit

    this->Write_Byte(F75111_INTERNAL_ADDR,GPIO2X_OUTPUT_DATA,byteData); // write byteData value via GPIO2X output pin
}
```

Get Input value

```
BYTE F75111::InterDigitalInput()
{
    BYTE byteGPIO1X = 0;
    BYTE byteGPIO3X = 0;
    BYTE byteData = 0;

    this->Read_Byte(F75111_INTERNAL_ADDR,GPIO1X_INPUT_DATA,&byteGPIO1X); // Get value from GPIO1X
    this->Read_Byte(F75111_INTERNAL_ADDR,GPIO3X_INPUT_DATA,&byteGPIO3X); // Get value from GPIO3X

    byteGPIO1X = byteGPIO1X & 0xF0;           // Mask unuseful value
    byteGPIO3X = byteGPIO3X & 0x0F;           // Mask unuseful value

    byteData = ( byteGPIO1X & 0x10 )? byteData + 0x01 : byteData;
    byteData = ( byteGPIO1X & 0x80 )? byteData + 0x02 : byteData;
    byteData = ( byteGPIO1X & 0x40 )? byteData + 0x04 : byteData;
    byteData = ( byteGPIO3X & 0x01 )? byteData + 0x08 : byteData;

    byteData = ( byteGPIO3X & 0x02 )? byteData + 0x10 : byteData;
    byteData = ( byteGPIO3X & 0x04 )? byteData + 0x20 : byteData;
    byteData = ( byteGPIO3X & 0x08 )? byteData + 0x40 : byteData;
    byteData = ( byteGPIO1X & 0x20 )? byteData + 0x80 : byteData;           // Get correct DI value from GPIO1X & GPIO3X

    return byteData;
}
```

Enable WatchDog

```
void F75111_SetWDTEnable (BYTE byteTimer)
{
    WriteByte(F75111_INTERNAL_ADDR,WDT_TIMER_RANGE ,byteTimer);           // set WatchDog range and timer
    WriteByte(F75111_INTERNAL_ADDR,WDT_CONFIGURATION,WDT_TIMEOUT_FLAG | WDT_ENABLE | WDT_PULSE | WDT_PSWIDTH_100MS);
                                                                           // Enable WatchDog, Setting WatchDog configure
}
```

Disable WatchDog

```
void F75111_SetWDTDisable ()  
{  
    WriteByte(F75111_INTERNAL_ADDR,WDT_CONFIGURATION,0x00); // Disable WatchDog  
}
```

1-2 IO Device: F75111 VB6 under Windows

The Sample code source you can download from

Source file: **75111_VB_v10.rar** http://tprd.info/lexwiki/index.php/IO_Device:F75111_VB6

Binary file: **75111_VB_Src.rar**

USERNAME & PASSWORD: **sf**

How to use this Demo Application

75111_DEMO VB v1.0

Please key-in the timer by sec !!

A **B**

Enable WDT Disable WDT

Please key-in the DO Value by hex !! exp:0xFF = FF

Set DO Value **C**

Push the Button will show the DI 1X_3X Value !!

D

Check DI Value 1X Value 2X Value

A Function - Enable WDT timer ,Key-in the value by seconds then system will reboot after value which you key-in in left text box !!

B Function - Disable WDT timer ,Push down the button then WDT timer value will be clear !!

C Function - Set DO Value ,Key-in the DO value by hex then push the button !!

D Function - Check DI Value ,The right side two text box will display DI 1X & 2X Value when you push down the button!!

SDK Function Introduction

Function EnableWDT

```
Function EnableWDT(timer As Integer)
```

```
Call Writel2CByte(&H3, &H3)
```

```
Call Writel2CByte(&H37, timer)
```

```
Call Writel2CByte(&H36, &H73)
```

```
End Function
```

Function DisableWDT

```
Function DisableWDT()
```

```
Call Writel2CByte(&H36, &H0)
```

```
End Function
```

Function SetDOValue

```
Function SetDOValue(dovalue As Integer)
```

```
Call Writel2CByte(&H23, &H0)
```

```
Call Writel2CByte(&H20, &HFF)
```

```
Call Writel2CByte(&H2B, &HFF)
```

```
Call Writel2CByte(&H21, dovalue)
```

```
End Function
```

Function CheckDIValue

```
Function CheckDIValue()
```

```
Dim GPIO1X As Integer
```

```
Dim GPIO3X As Integer
```

```
Dim DI1Xhex As String
```

```
Dim DI3Xhex As String
```

```
Call Readl2CByte(&H12, GPIO1X)
```

```
Call Readl2CByte(&H42, GPIO3X)
```

```
DI1Xhex = Hex(GPIO1X)
```

```
DI3Xhex = Hex(GPIO3X)
```

```
Text3.Text = "0x" + DI1Xhex
```

```
Text4.Text = "0x" + DI3Xhex
```

```
End Function
```

1-3 IO Device: F75111 under linux

The Sample code source you can download from

Source file: F75111v2.0L.tar.gz http://tprd.info/lexwiki/index.php/IO_Device:F75111_under_linux

Binary file: F75111v2.0LBin.tar.gz

USERNAME & PASSWORD: sf

How to compile source code

1. Compile source code with Code::Blocks

download and install the Code::Block with command "apt-get install codeblocks"

Open an exist project(F75111.cbp) in Code::Blocks, click the compile button

(add an option 'pkg-config --libs gtk+-2.0 gthread-2.0' in "Project->Build Option->Linker Setting->Other linker option")

2. Compile source code with "make"

1.cd F75111

1.make

1.src/f75111 // execute the binary file

How to use this Demo Application



1. Press the "Start" button to test DIO function
2. Press the "Enable" button to test WDT function
3. Press the "Disable" button to disable WDT
4. Check the "Enable Loop" box and press "Enable" to do WDT loop test
5. Press "Install" to set the system to autorun this application when booting, press "Uninstall" to remove this application when booting.
6. If WDT enable, system icon will be blinking.

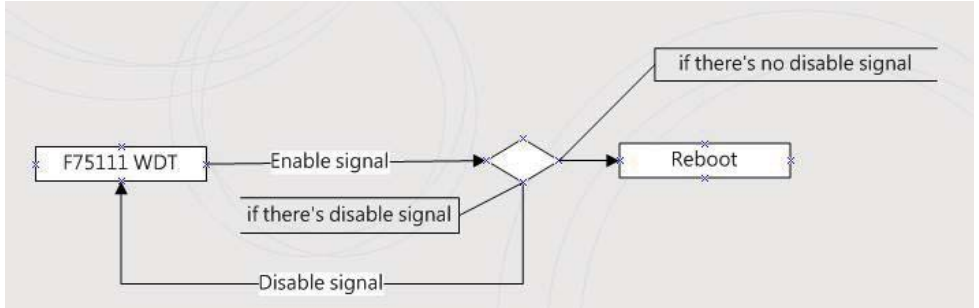

p.s.
 f75111 send "F75111_SetWDTEnable(BYTE byteTimer)" including a parameter "timer",
 if there's no disable signal (F75111_SetWDTDisable()) to stop it before timer countdown to 0, System will reboot.
 if there's disable signal received, resent Enable WDT signal, for a loop to prevent from reboot p.s.

Introduction

IO function In file SMBus.c

```

void SMBusIoWrite(BYTE byteOffset,BYTE byteData)
{
    outb( byteData , m_SMBusMapIoAddr + byteOffset);
}

BYTE SMBusIoRead(BYTE byteOffset)
{
    DWORD dwAddrVal;

    dwAddrVal = inb(m_SMBusMapIoAddr + byteOffset);
    return (BYTE)(dwAddrVal & 0xFF);
}
  
```

Initial internal F75111

```

void F75111::InitInternalF75111()
{
    this->Write_Byte(F75111_INTERNAL_ADDR,GPIO1X_CONTROL_MODE ,0x00); //set GPIO1X to Input function
    this->Write_Byte(F75111_INTERNAL_ADDR,GPIO3X_CONTROL_MODE ,0x00); //set GPIO3X to Input function
    this->Write_Byte(F75111_INTERNAL_ADDR,GPIO2X_CONTROL_MODE ,0xFF); //set GPIO2X to Output function

    this->Write_Byte(F75111_INTERNAL_ADDR,F75111_CONFIGURATION, 0x03); //Enable WDT OUT function
}
  
```

Set output value

```
void F75111::InterDigitalOutput(BYTE byteValue)
{
    BYTE byteData = 0;
    byteData = (byteData & 0x01 )? byteValue + 0x01 : byteValue;
    byteData = (byteData & 0x02 )? byteValue + 0x02 : byteValue;
    byteData = (byteData & 0x04 )? byteValue + 0x04 : byteValue;
    byteData = (byteData & 0x08 )? byteValue + 0x08 : byteValue;
    byteData = (byteData & 0x10 )? byteValue + 0x10 : byteValue;
    byteData = (byteData & 0x20 )? byteValue + 0x20 : byteValue;
    byteData = (byteData & 0x40 )? byteValue + 0x40 : byteValue;
    byteData = (byteData & 0x80 )? byteValue + 0x80 : byteValue;           // get value bit by bit

    this->Write_Byte(F75111_INTERNAL_ADDR,GPIO2X_OUTPUT_DATA,byteData); // write byteData value via GPIO2X output pin
}
```

Get Input value

```
BYTE F75111::InterDigitalInput()
{
    BYTE byteGPIO1X = 0;
    BYTE byteGPIO3X = 0;
    BYTE byteData = 0;

    this->Read_Byte(F75111_INTERNAL_ADDR,GPIO1X_INPUT_DATA,&byteGPIO1X); // Get value from GPIO1X
    this->Read_Byte(F75111_INTERNAL_ADDR,GPIO3X_INPUT_DATA,&byteGPIO3X); // Get value from GPIO3X

    byteGPIO1X = byteGPIO1X & 0xF0;           // Mask unuseful value
    byteGPIO3X = byteGPIO3X & 0x0F;           // Mask unuseful value

    byteData = ( byteGPIO1X & 0x10 )? byteData + 0x01 : byteData;
    byteData = ( byteGPIO1X & 0x80 )? byteData + 0x02 : byteData;
    byteData = ( byteGPIO1X & 0x40 )? byteData + 0x04 : byteData;
    byteData = ( byteGPIO3X & 0x01 )? byteData + 0x08 : byteData;

    byteData = ( byteGPIO3X & 0x02 )? byteData + 0x10 : byteData;
    byteData = ( byteGPIO3X & 0x04 )? byteData + 0x20 : byteData;
    byteData = ( byteGPIO3X & 0x08 )? byteData + 0x40 : byteData;
    byteData = ( byteGPIO1X & 0x20 )? byteData + 0x80 : byteData;           // Get correct DI value from GPIO1X & GPIO3X

    return byteData;
}
```

Enable WatchDog

```
void F75111_SetWDTEnable (BYTE byteTimer)
{
    WriteByte(F75111_INTERNAL_ADDR,WDT_TIMER_RANGE ,byteTimer);           // set WatchDog range and timer
    WriteByte(F75111_INTERNAL_ADDR,WDT_CONFIGURATION,WDT_TIMEOUT_FLAG | WDT_ENABLE | WDT_PULSE | WDT_PSWIDTH_100MS);
                                                                           // Enable WatchDog, Setting WatchDog configure
}
```

Disable WatchDog

```
void F75111_SetWDTDisable ()
{
    WriteByte(F75111_INTERNAL_ADDR,WDT_CONFIGURATION,0x00);           // Disable WatchDog
}
```